

Akal Takht

Building Guide V1.2



LOHGARH LLC

© 2017 Lohgarh LLC

All Rights Reserved

Introduction

The word 'Akal' means 'immortal' or beyond time and Takht means a throne. In literal terms, the Akal Takht is the Immortal throne. It is also known as Akal Bunga or Akaliya da Bunga, Immortal Fortress or Fortress of the Immortals respectively. Akal Takht Sahib is the throne of Guru Granth Sahib Ji and Guru Khalsa Panth.

Akal Takht Sahib is located at Darbar Sahib Amritsar, Panjab. It's relative location to Harmandir Sahib can be seen below:

Each of the Gurus gradually manifested the sociopolitical sovereignty of the Guru leading up to the construction of Akal Takht Sahib:

- **Guru Nanak Sahib** - Dharamsalas created wherever visited.
Headquarters: Kartarpur Sahib Guru
- **Guru Amar Das Sahib** - Organized Sikhs into 22 zones called Manjis.
Headquarters: Goindval Sahib
- Supremacy of Sangat Declared
- **Guru Ram Das Sahib & Bibi Bhani** - Founded and built Ramdaspur (Amritsar)
- **Guru Arjan Sahib** - built Harmandir Sahib
- **Guru Hargobind Sahib** - built Akal Takht Sahib

At this place, Guru Hargobind Sahib used to hold his court, where spiritual, social, and political concerns of the Sikh people could be addressed.

The construction of Akal Takht was a bold and dramatic declaration of complete sovereignty of the Sikhs. In contrast to Harmandir Sahib, Akal Takht was built exclusively by Guru Hargobind Sahib himself and his two most exemplary Sikhs: Bhai Gurdas and Baba Buddha. As a political, social, judicial, military seat of power, the Akal Takht was open only to those



who had made a firm commitment to the Guru. Harmandir Sahib is open to all, especially non-Sikhs. Akal Takht Sahib is not simply a 'house of worship.' It is the center of the Sikhs sovereign power.

The Akal Takht has its own traditions. For example, Rehras Sahib and Ardas are recited here with a naked sword in hand. Weapons of the Sikh Gurus and Sikh warriors are displayed in the Palki Sahib.

Level 1

Step 1



2



1

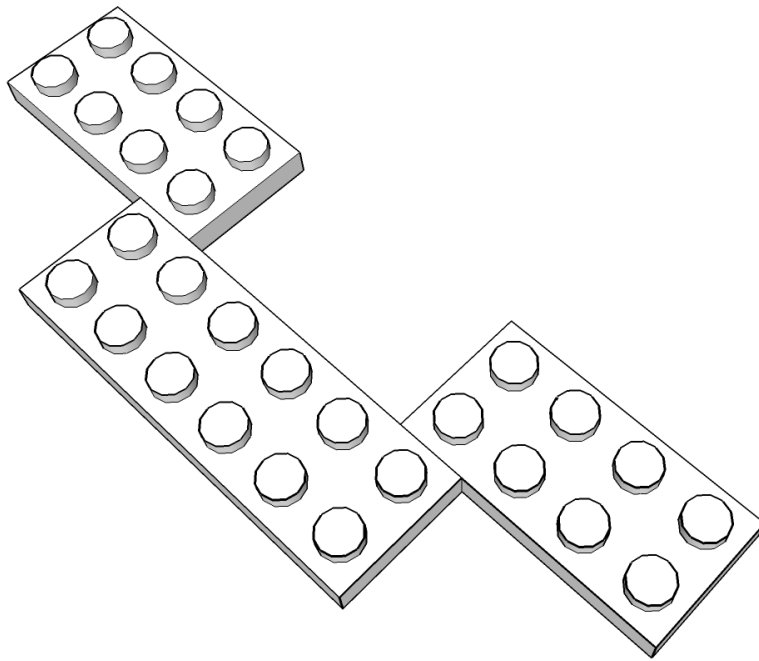

Step 2

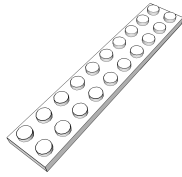

1

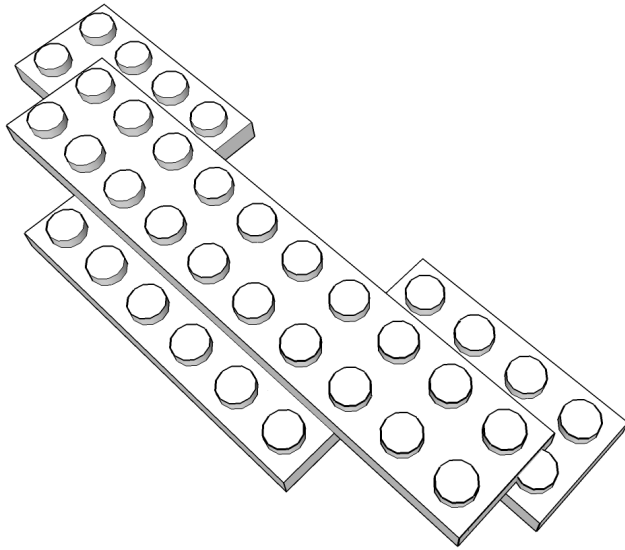

Step 3

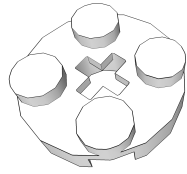

4



2

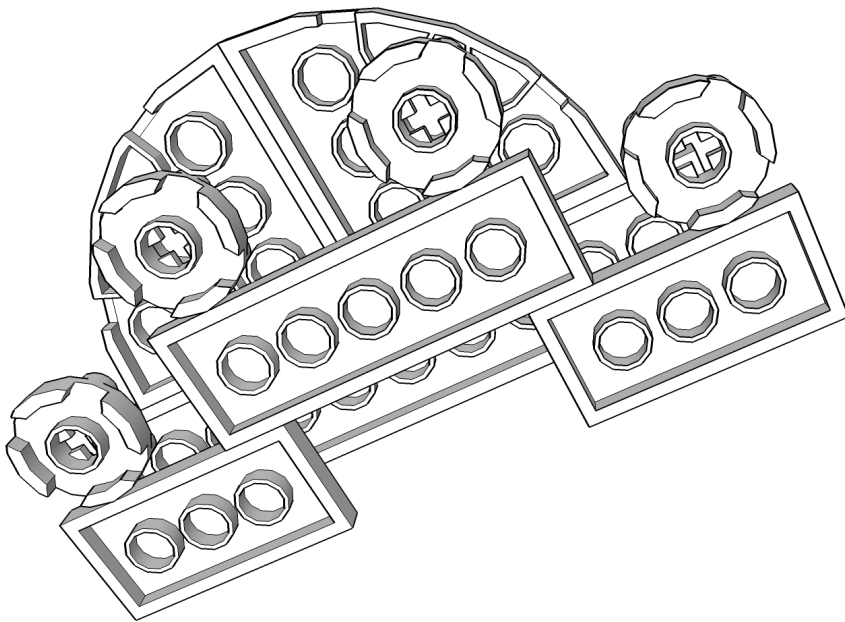

Step 4

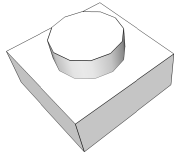

2

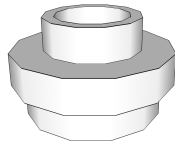

6

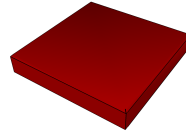

1

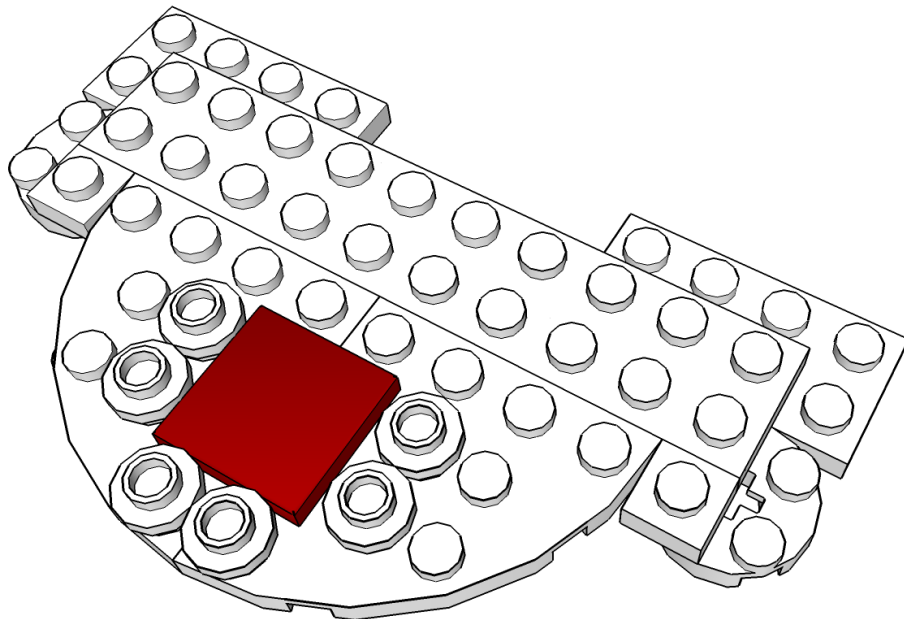

Step 5

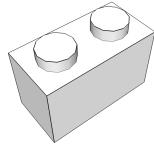

4

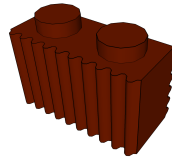

1

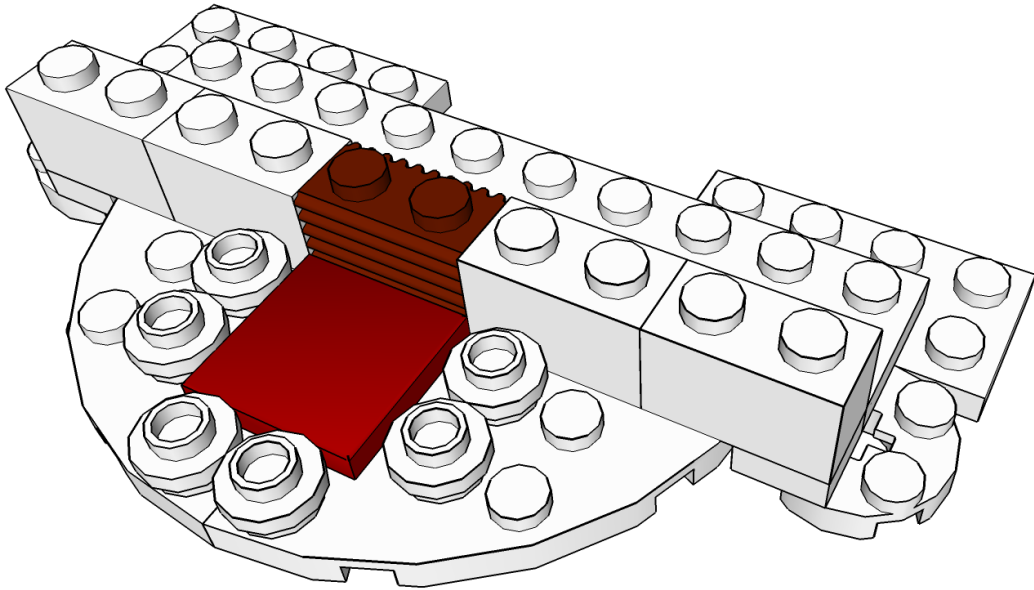

Step 6

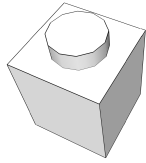

4

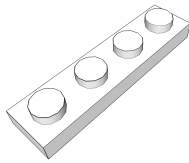

1

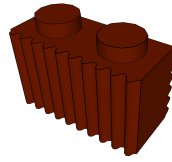

1

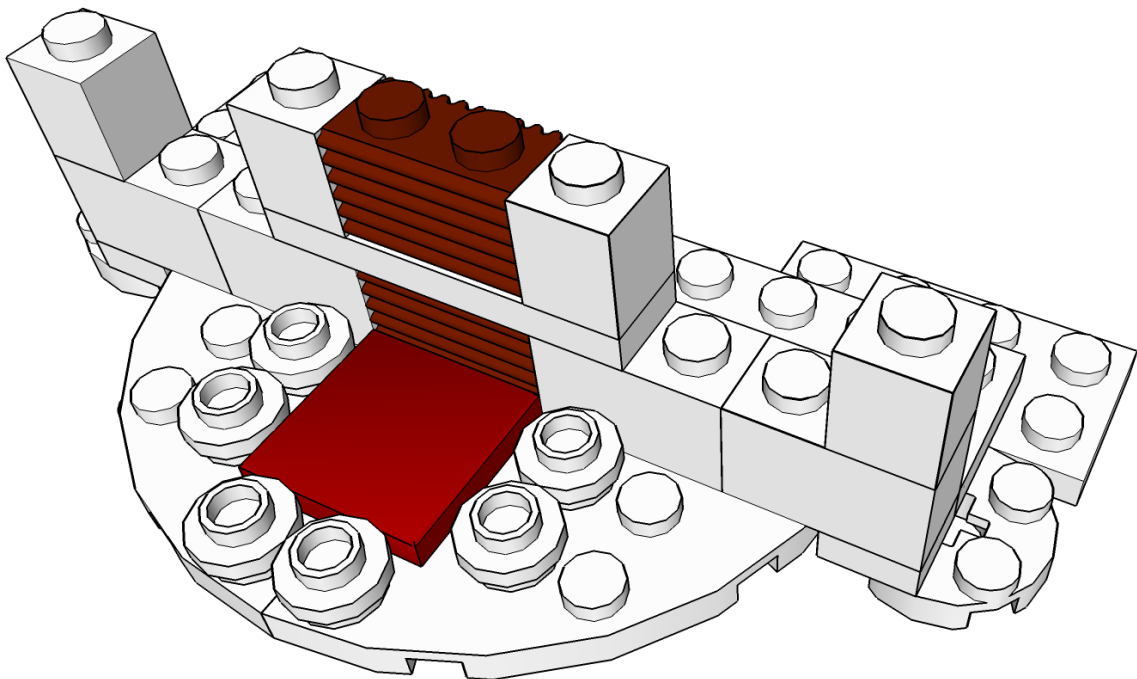

Step 7

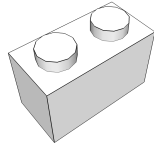

2

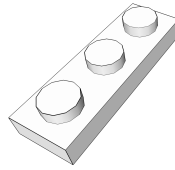

2

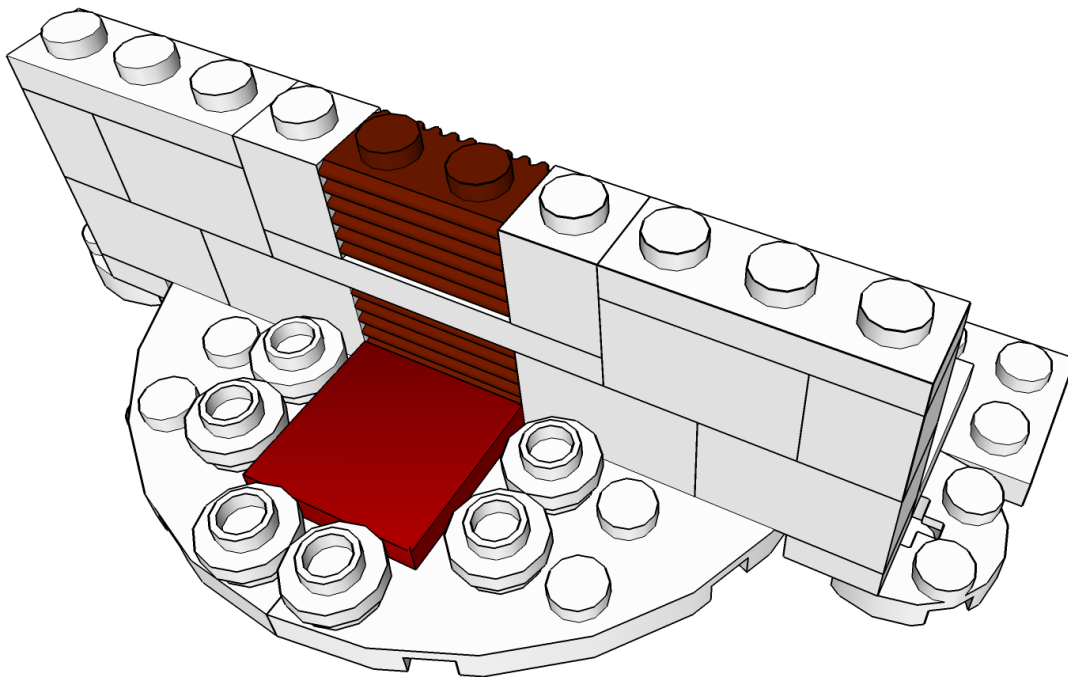

Step 8

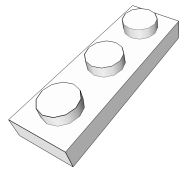

2

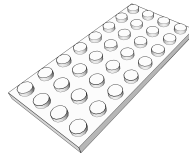

2

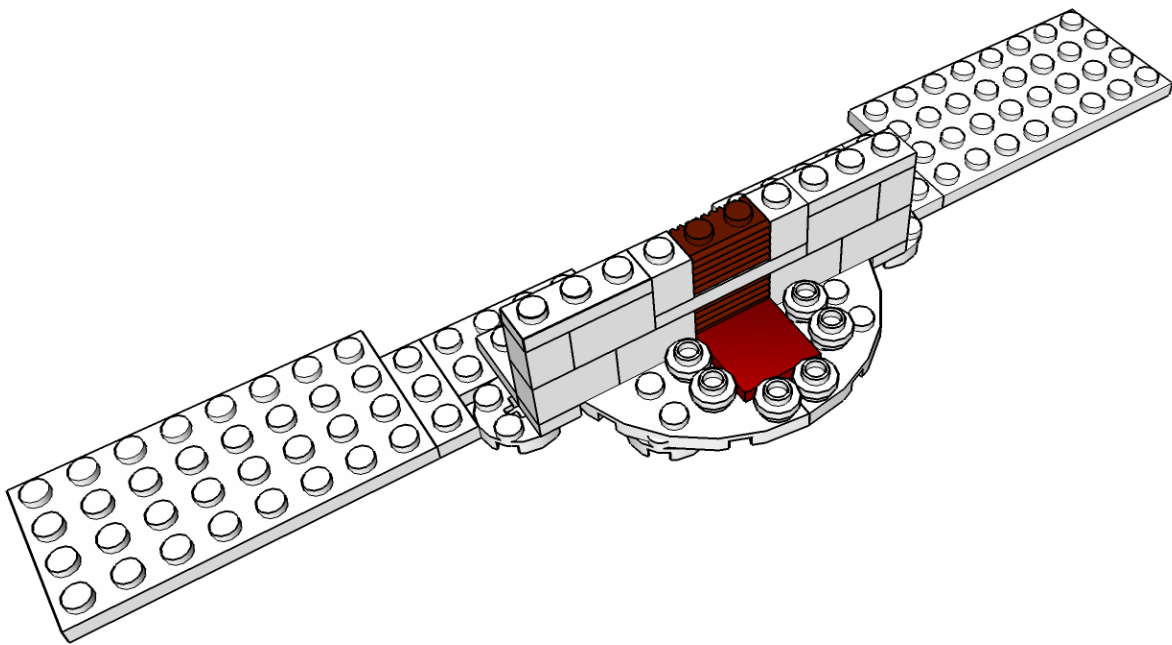

Step 9

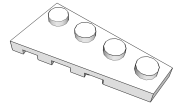

1



1

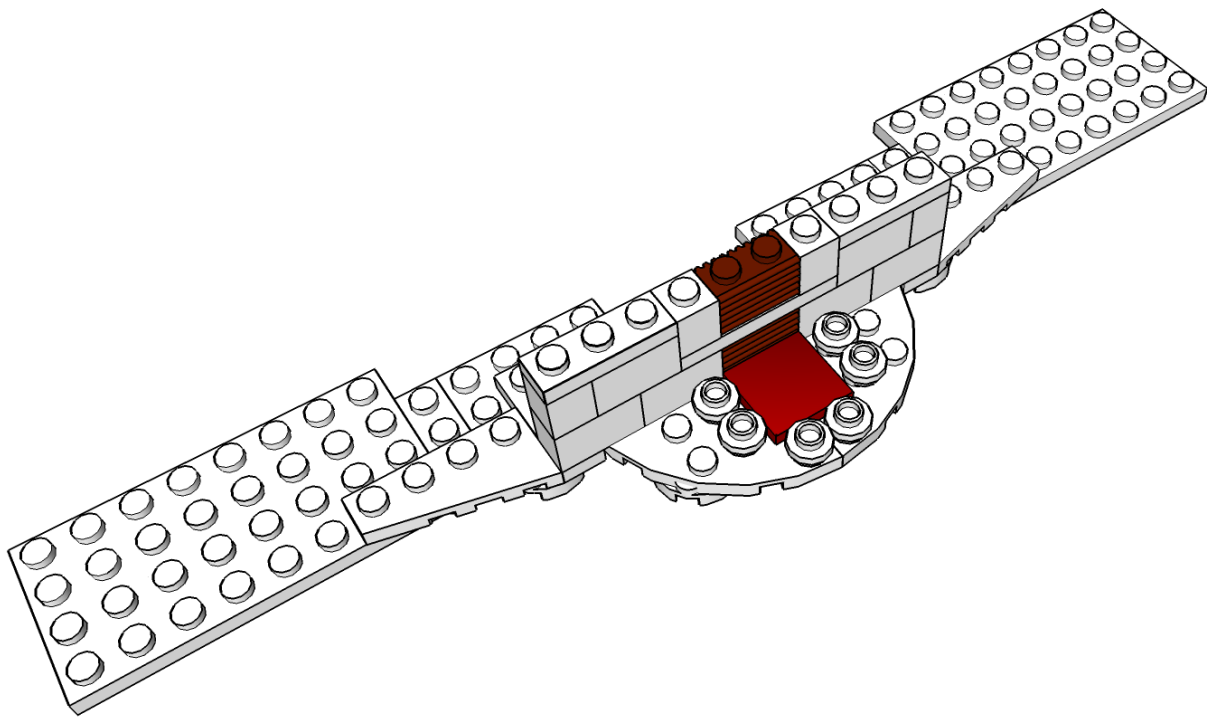

Step 10

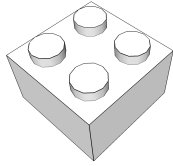

4



2

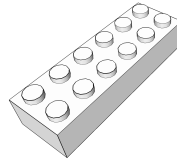

2

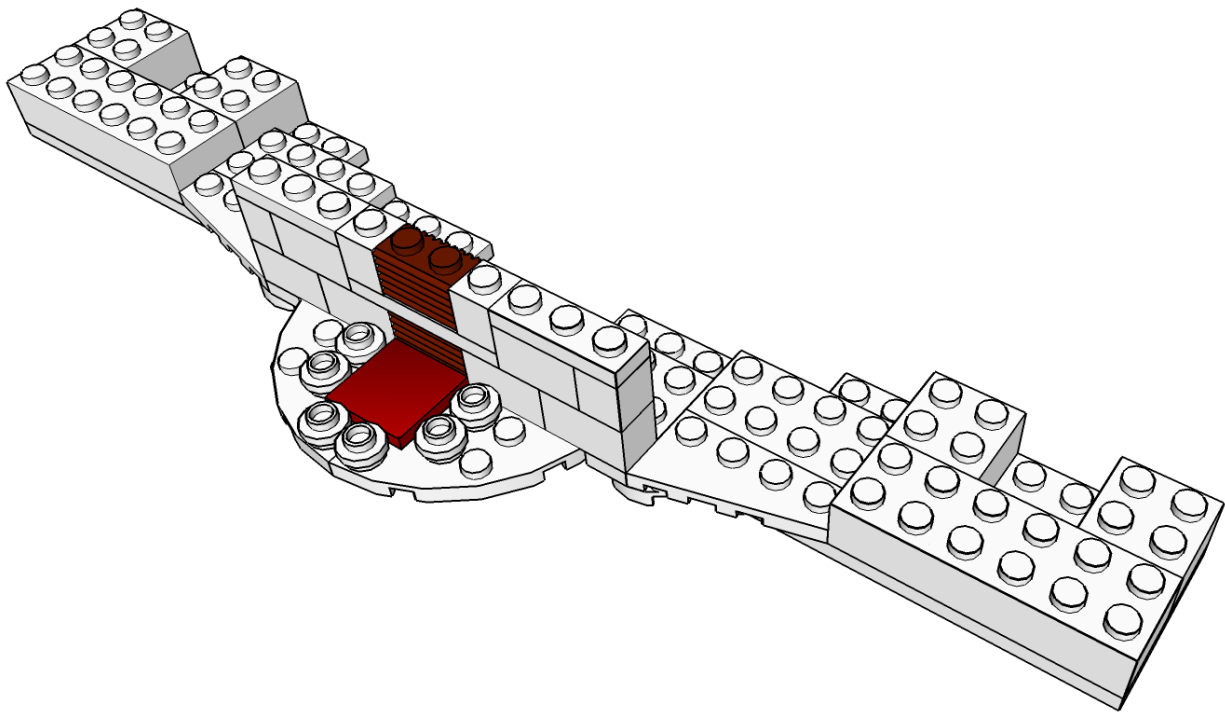

Step 11

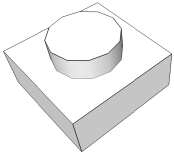

2

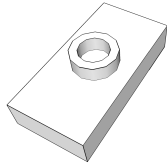

4

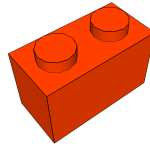

2

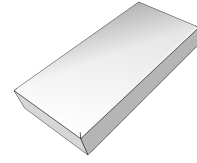

2

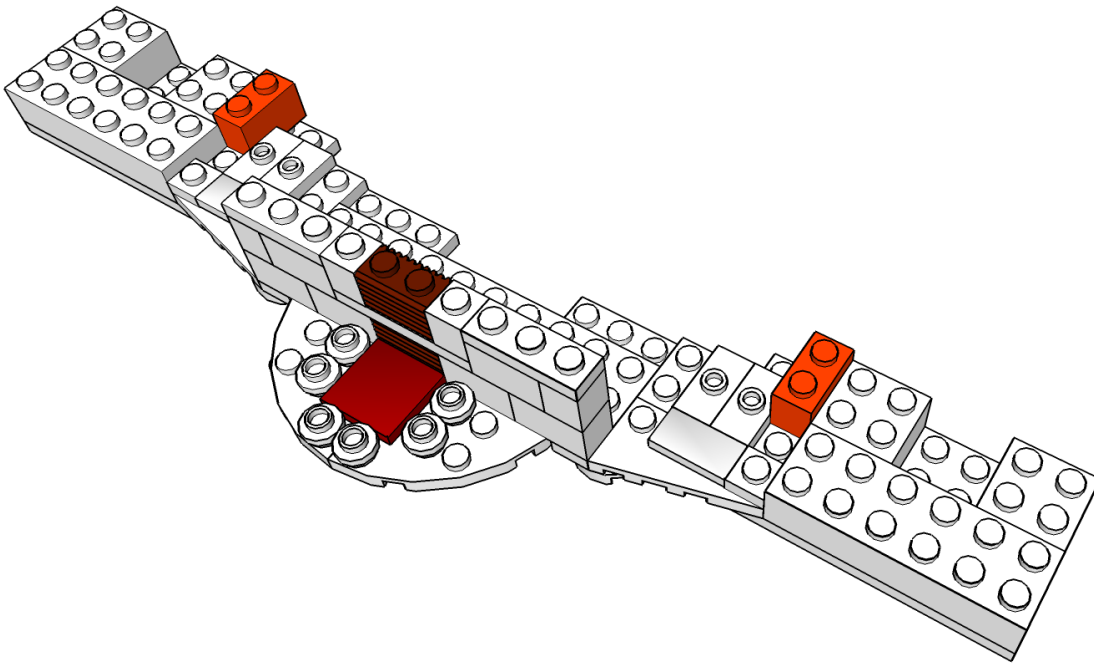

Step 12

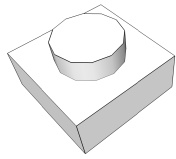

2

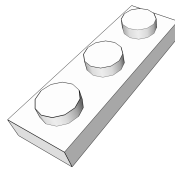

2

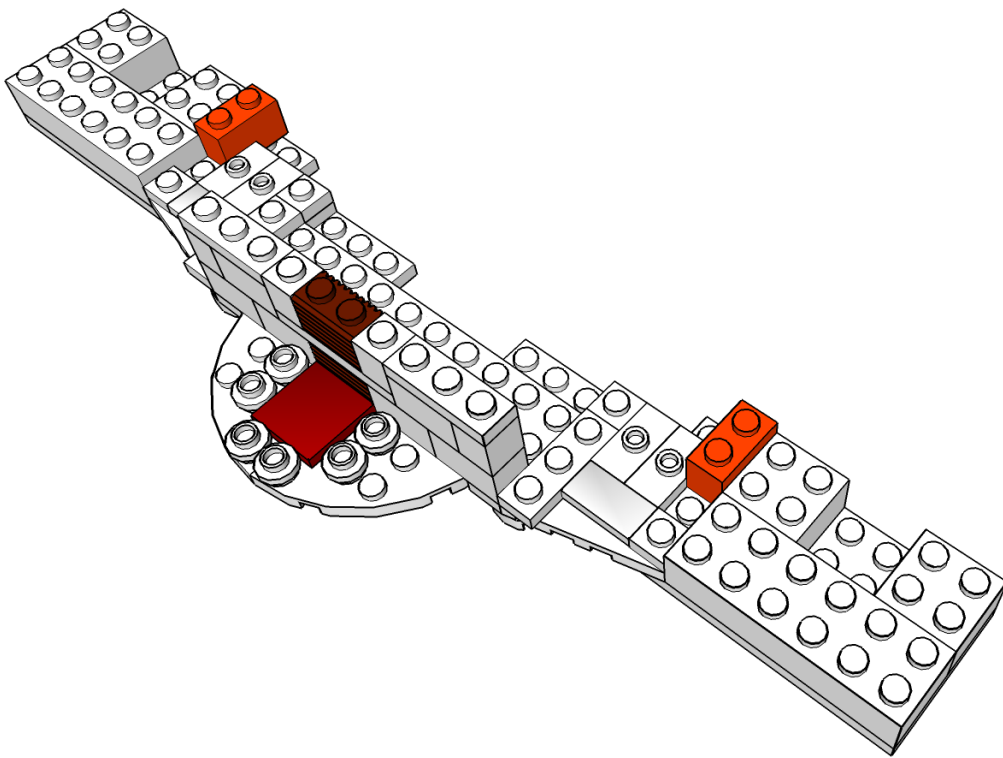

Step 13

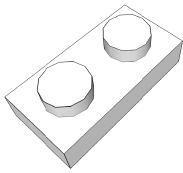

2

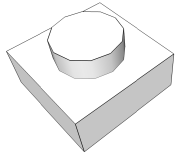

2



2

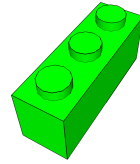

2

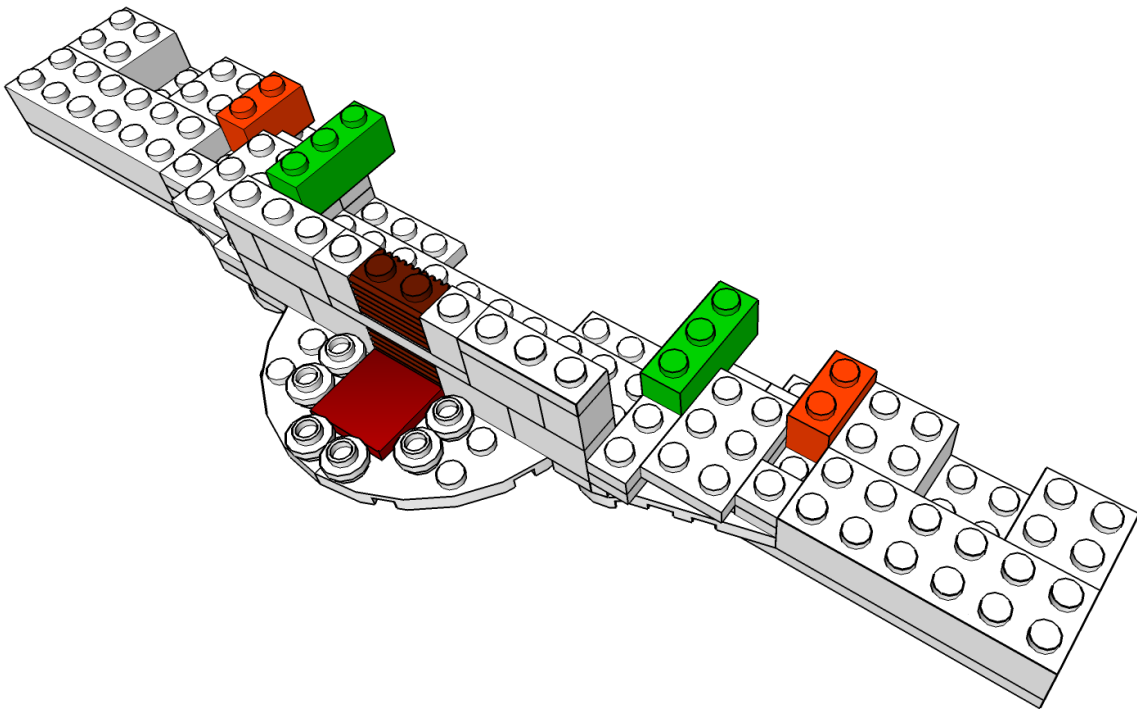

Step 14

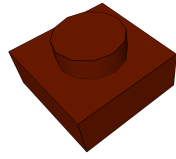

4

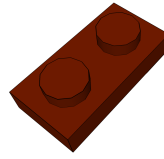

2

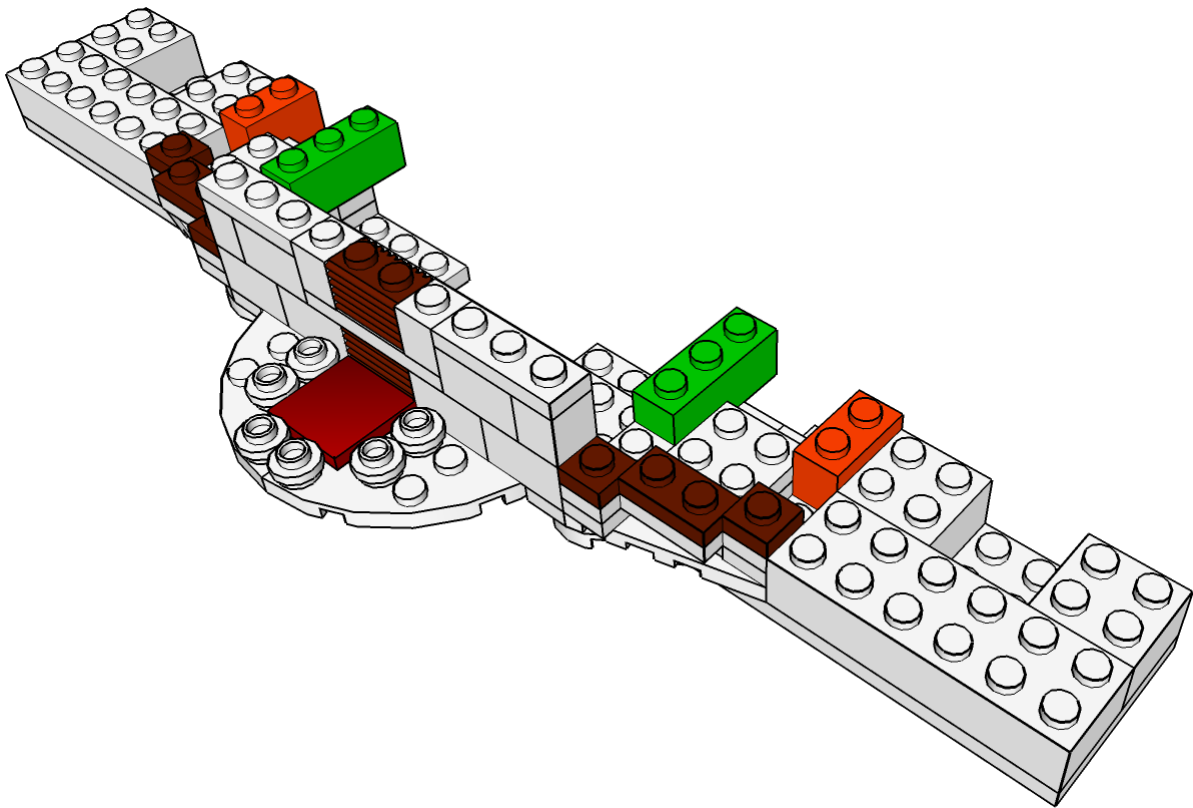

Step 15

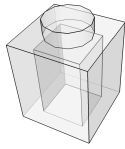

8

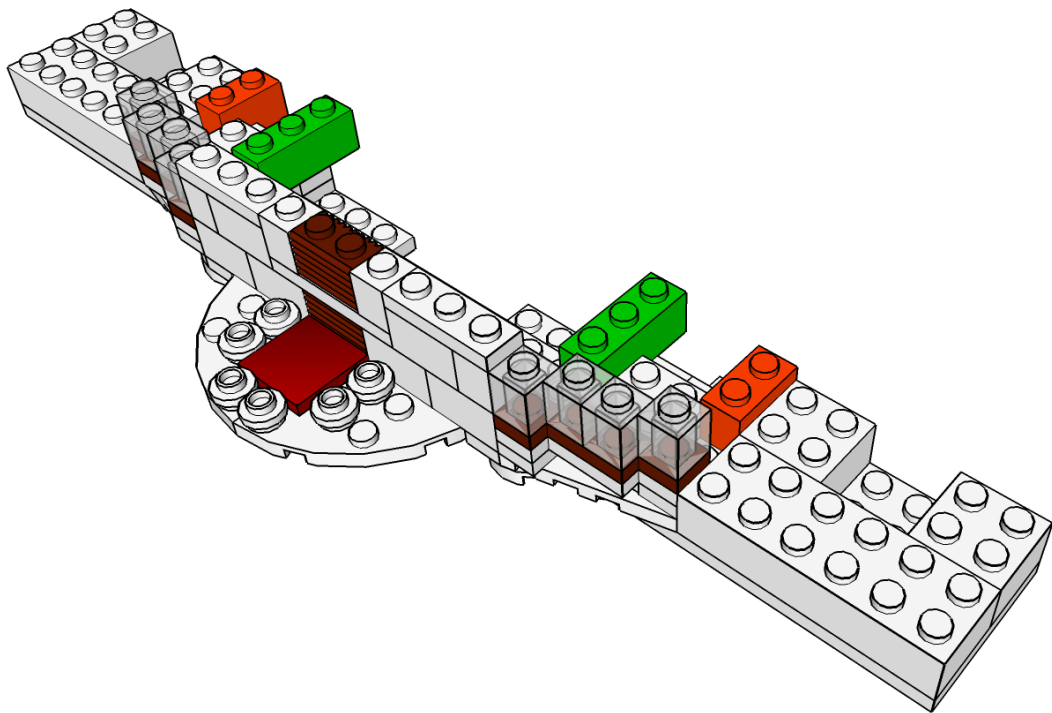

Step 16

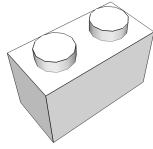

2

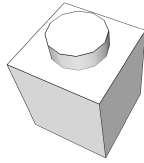

2

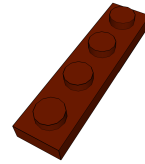

2

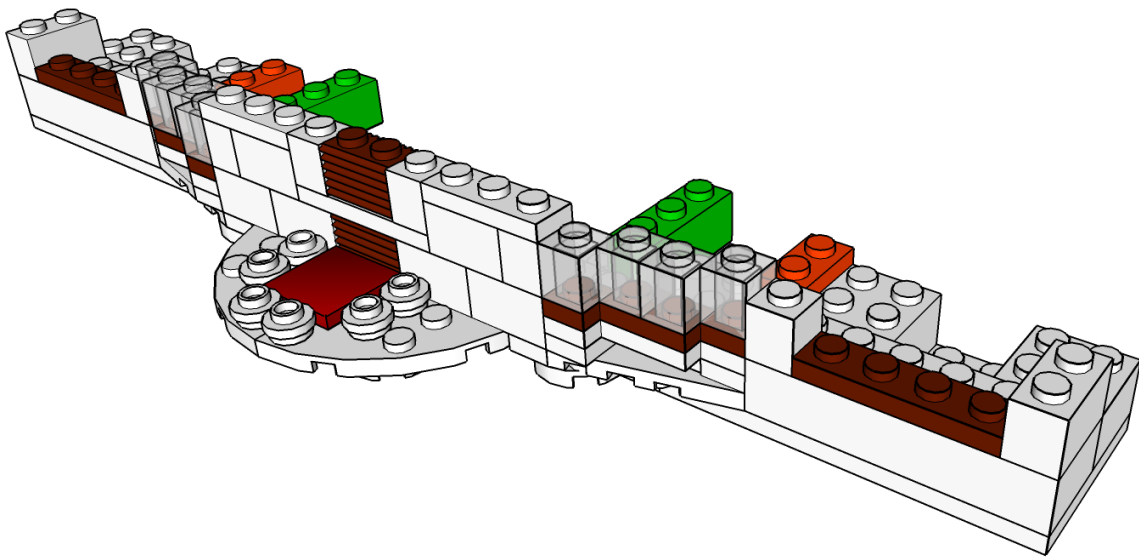

Step 17

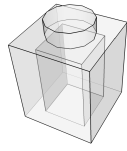

8

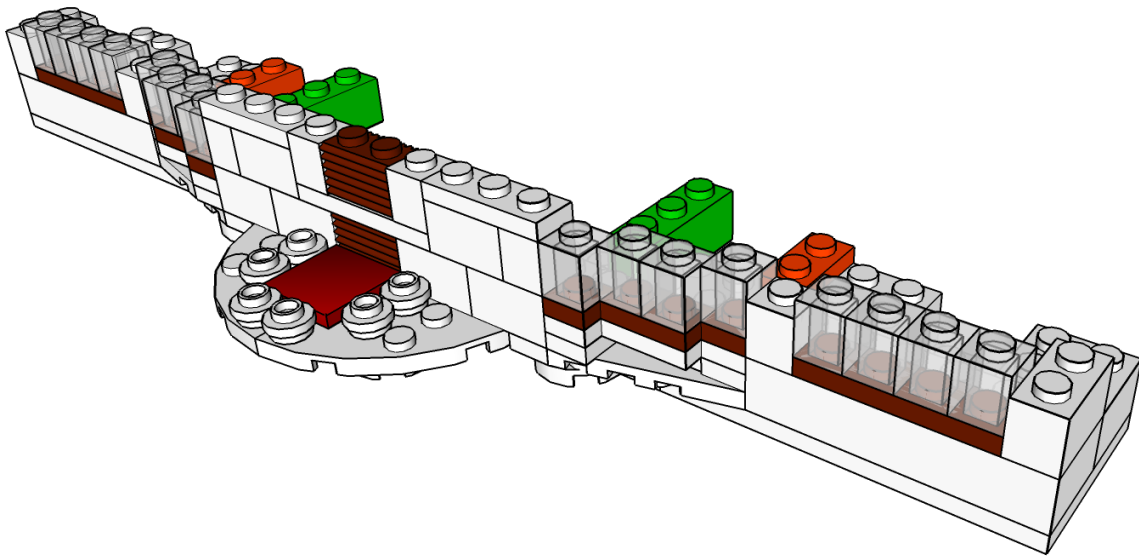

Step 18

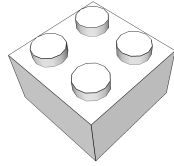

4

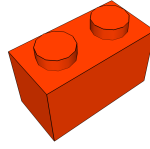

2

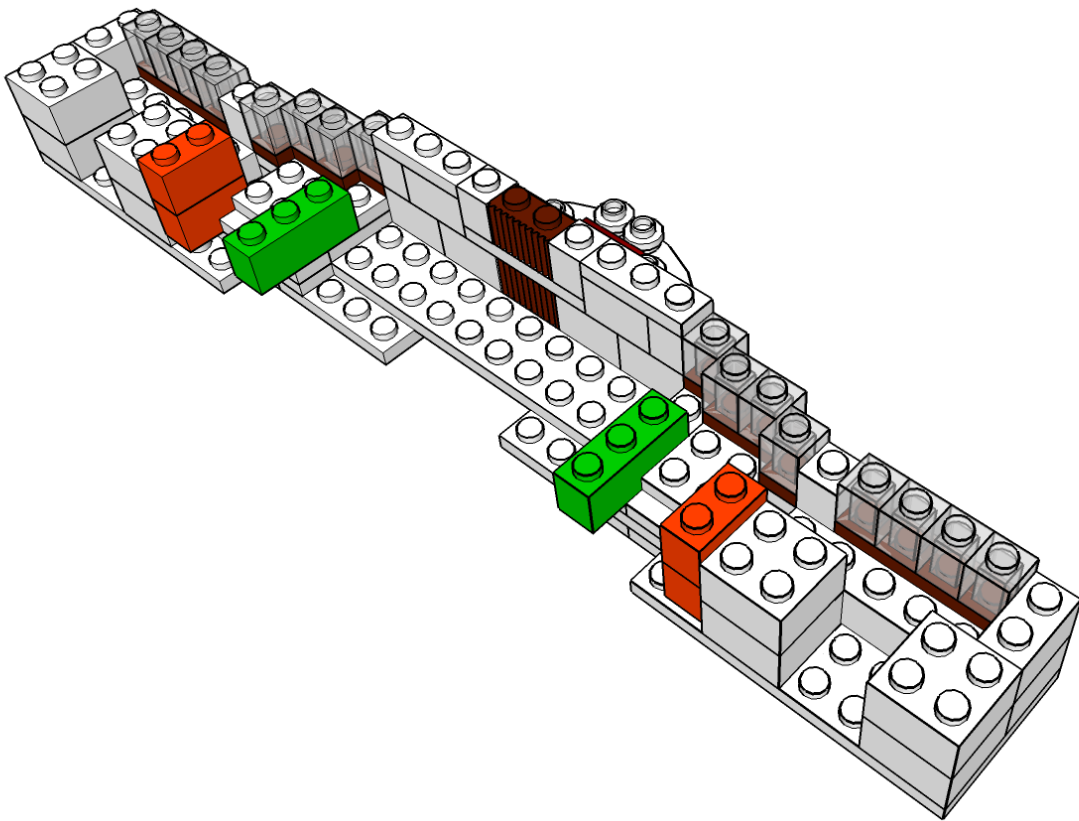

Step 19

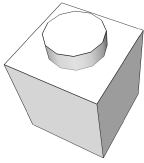

2

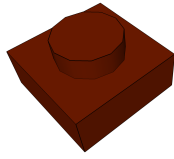

4

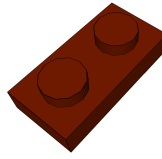

2

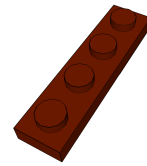

2

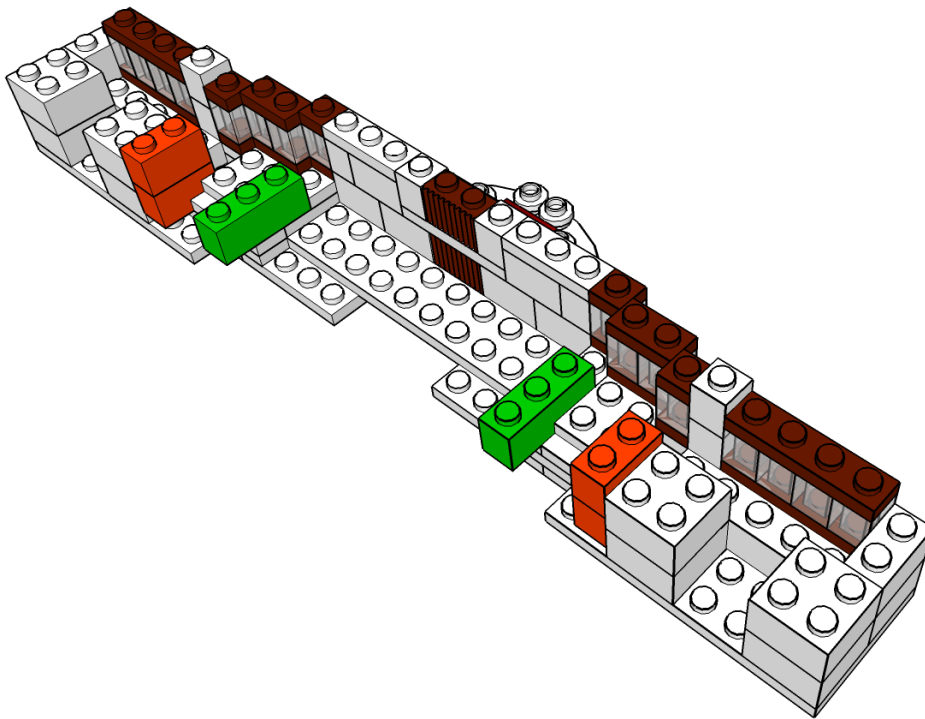

Step 20

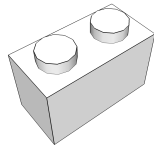

2

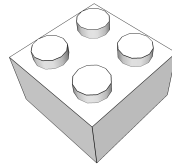

4

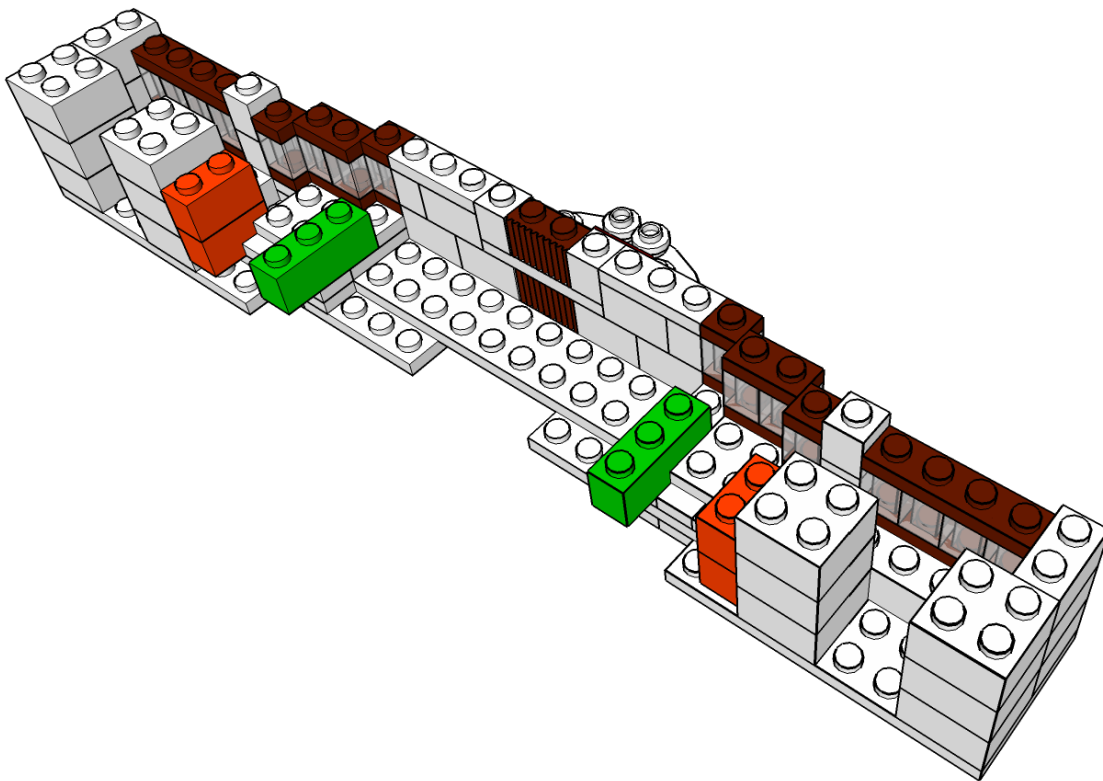

Step 21

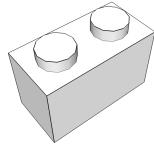

2



6

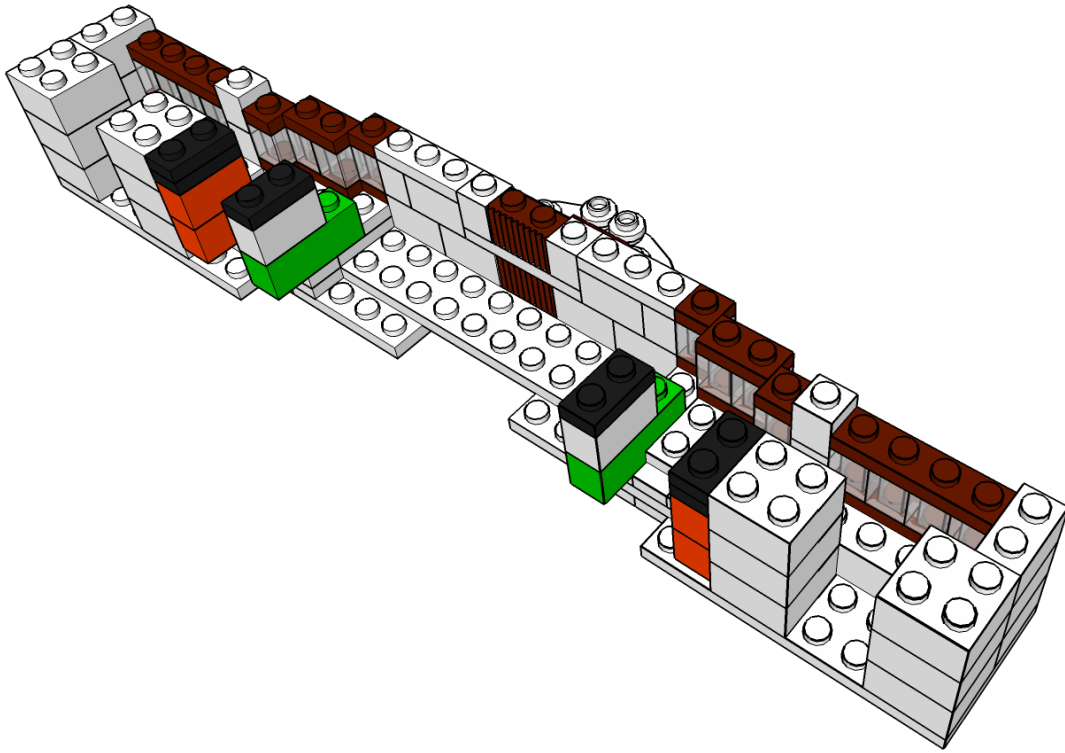

Step 22

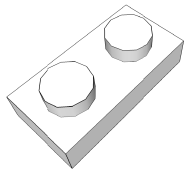

4

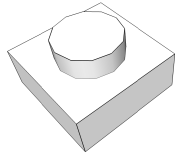

2

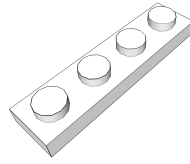

2

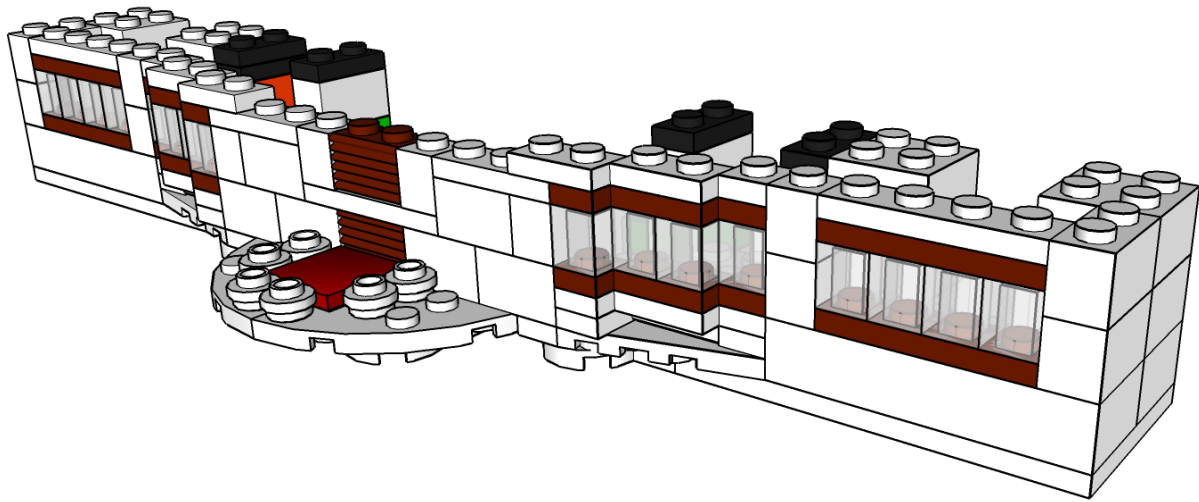

Step 23



6

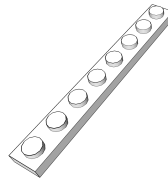

1

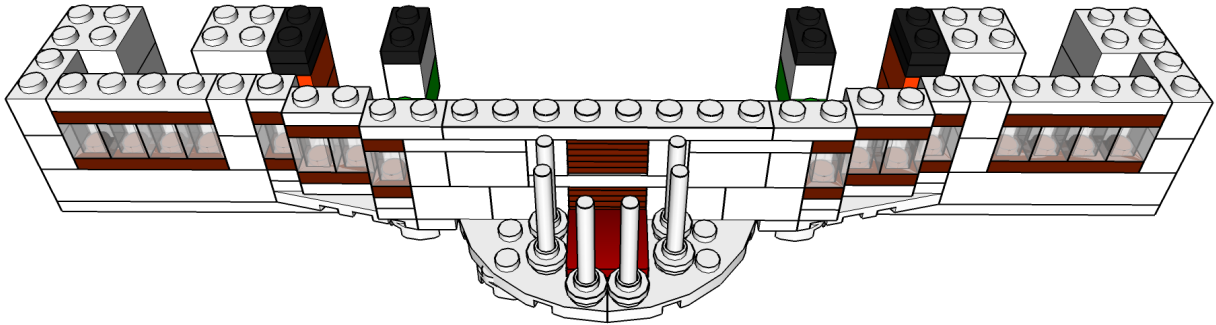

Step 24

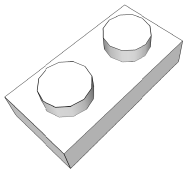

2



4

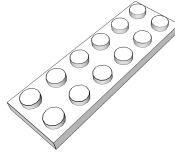

2



2

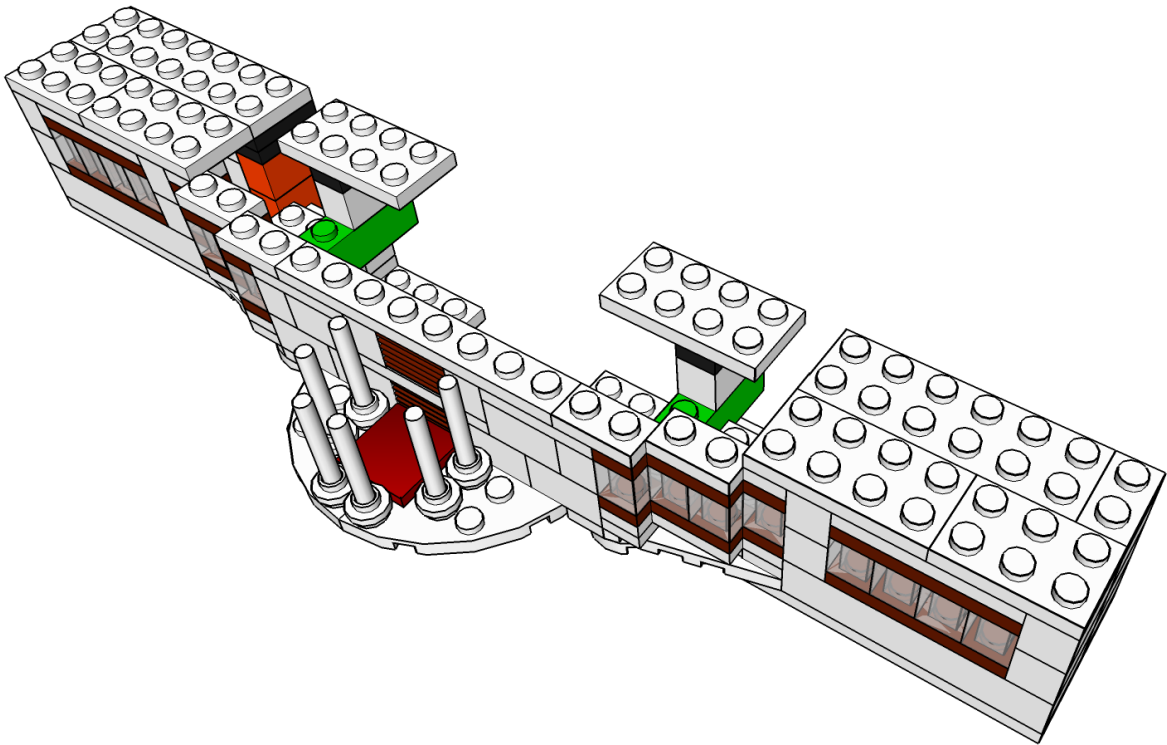

Step 25

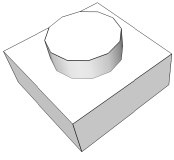

2

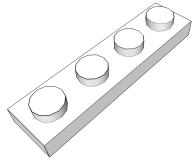

2

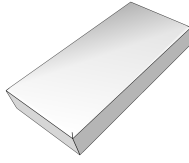

2



1

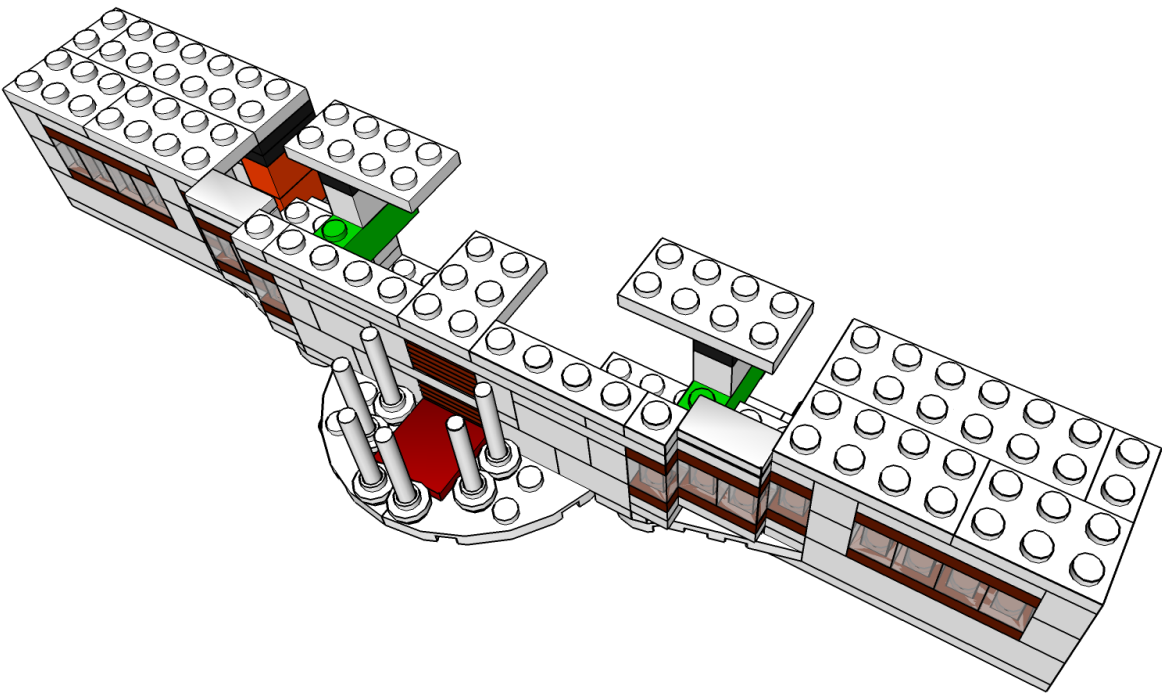

Step 26



2

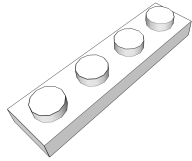

2

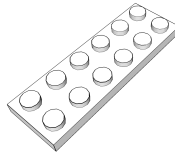

4

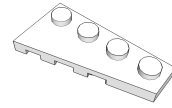

1



1

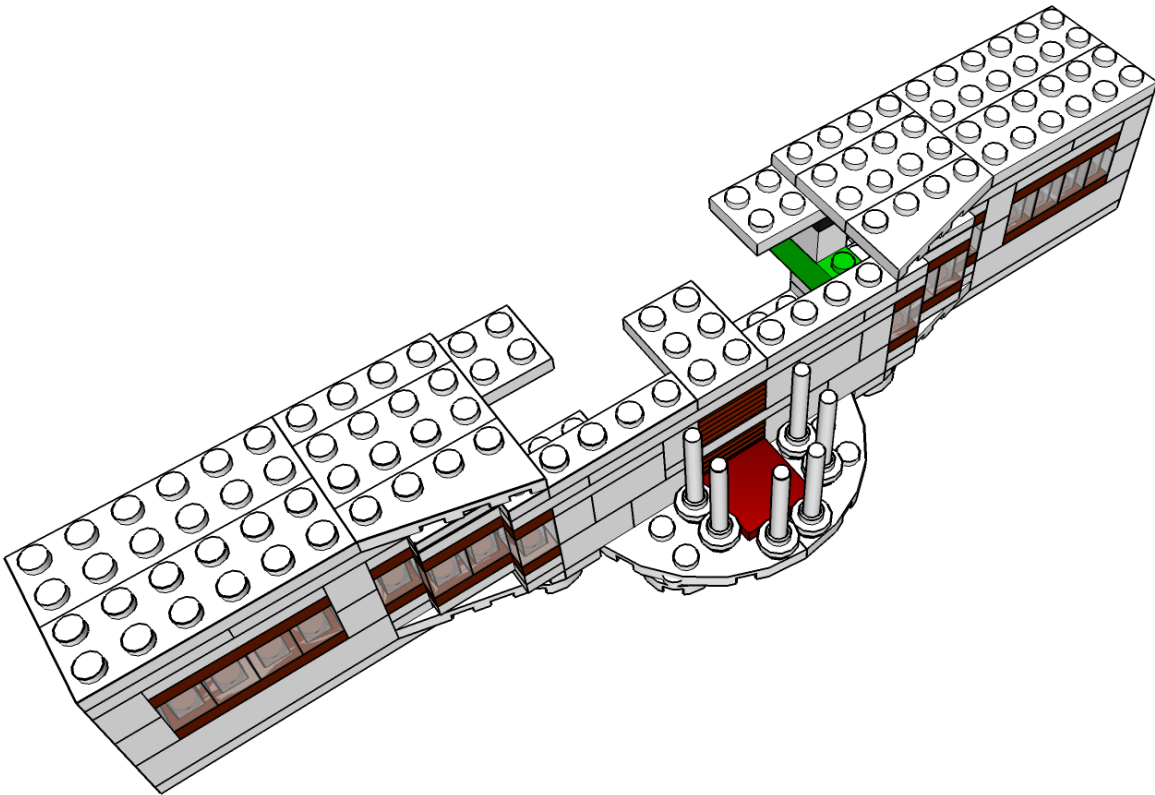

Step 27

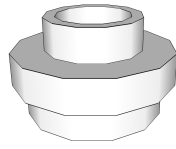

6

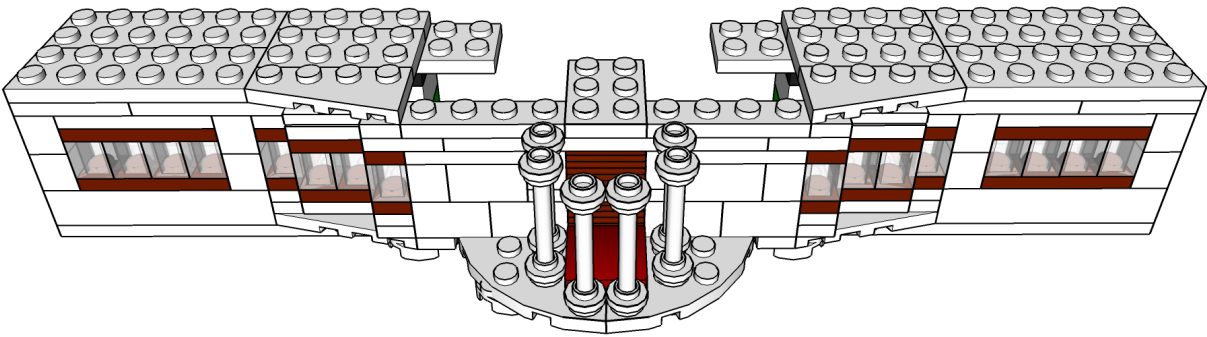

Step 28

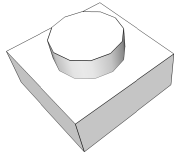

2



2

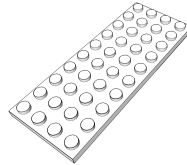

1

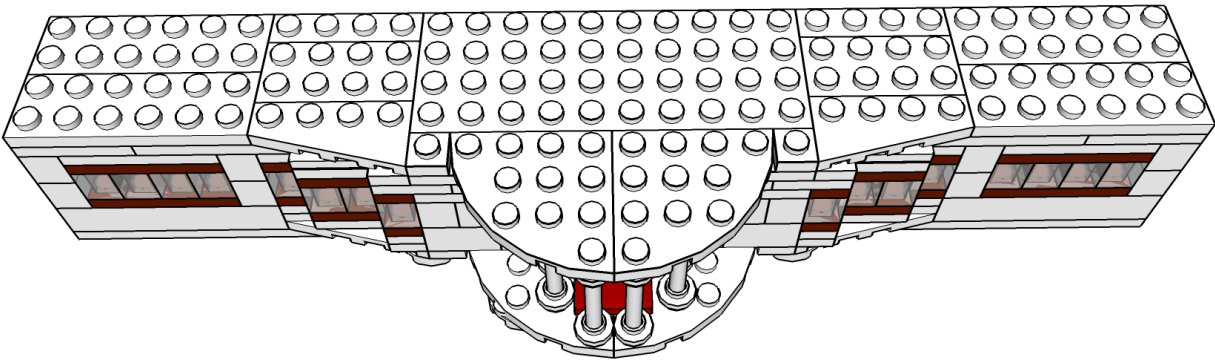

Historical Beginnings

During the excavation for the sarovar of Harimandir Sahib, a high mound of earth had collected across the wide open space in front. It was a place where Guru Hargobind Sahib Ji played as a child. After the Adi Granth Sahib was installed in Harimandir Sahib in 1604, it was brought to a room near here every night from Harimandar Sahib. Guru Arjan Dev Ji used to rest under the cot meant for the Adi Granth Sahib. This room is now known as Kotha Sahib. The earth was levelled from above and a pacca floor was laid. A big raised platform of bricks was constructed to serve as a seat for the Guru. Later a big hall was constructed on that site.

Before Guru Hargobind Sahib Ji's accession to the gaddi, Harimandir Sahib at Amritsar was the place where the Guru Arjan Dev Ji used to sit and give guidance to the Sikhs and preside over wrestling matches. Here Guru Hargobind Sahib was ceremoniously installed as the Guru in 1606. The young Guru took the seat of his father with two swords girded round his waist, one to symbolize worldly power and the other, spiritual power i.e., Miri and Piri. The Guru played the dual role of a Mir (a Political leader) and a Pir (a spiritual leader).

According to Guru Bilas Patshahi Chhevin, the foundation laying ceremony of Akal Takht was performed by Baba Buddha and Bhai Gurdas, two of the most committed Sikhs at the Guru's court. Baba Buddha Ji and Bhai Gurdas constructed the Takht under direction of Guru Hargobind Sahib.

The original takht was a simple platform, 3.5 meters (11 ft.) high and stood a little taller than the Mughal Emperors throne in Red Fort Delhi intentionally as a statement about the sovereignty of the Sikhs outside the other worldly Governments. Guru Hargobind Sahib would sit in court to receive petitions and administer justice. He was surrounded by insignia of royalty such as the parasol and the flywhisk. Many Sikhs gathered here for the redressal of their grievances. The Guru desired the Sikhs to bring arms and horses as part of their offerings in order to uphold the sovereignty of the Guru and the Sangat. This was readily done and some of them personally joined Darbar Sahibs armed gaurd. Here, Guru

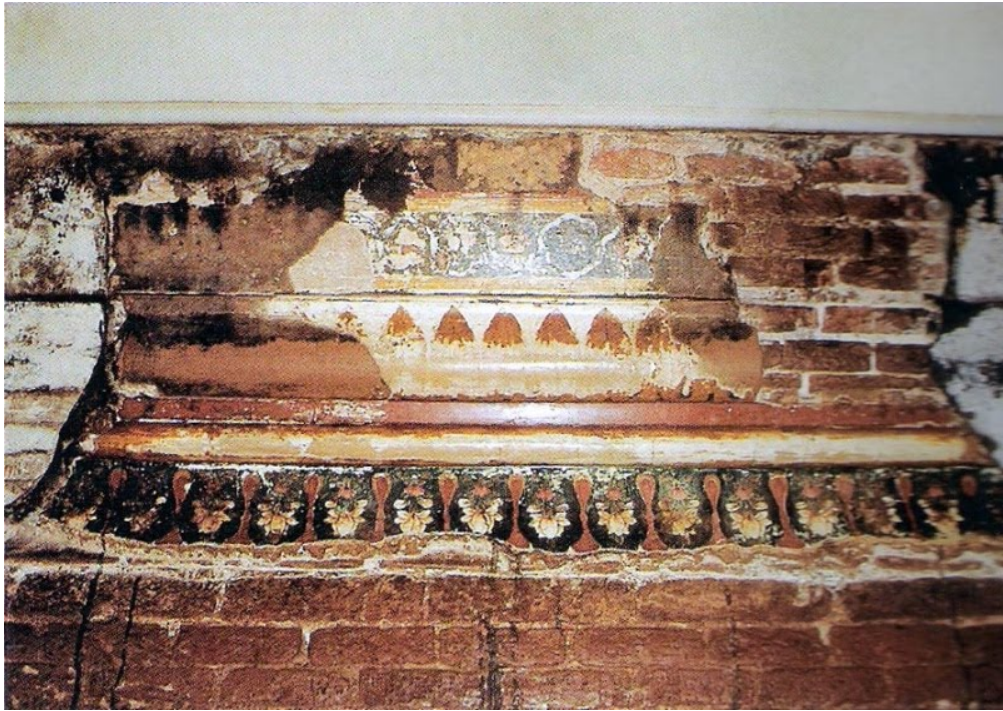



Hargobind Sahib watched the Sikhs performing exercises in the art of warfare.

At the Akal Takht, the Guru held symposiums of martial music and the heroic deeds of historical personalities were narrated. Guru Hargobind introduced congregational prayers which added fervor in the minds of the Sikhs and strengthened feelings of unity, cooperation, and nationhood among them. Under him was also established the custom, which still continues, of choirs moving nightly round the sarovar of Darbar Sahib, with the blare of trumpets and flare of torches, singing hymns in soul stirring tunes. All these programs put a new life into the hearts of the Sikhs which helped solidify the distinct sovereign culture of the people. The tradition of singing ballads of war heroes with stringed instrument (Sarangi and Dhadi) began here and the tradition is still going until this day.

According to Teja Singh and Ganda Singh, Jahangir paid a visit to Amritsar and offered to complete the building of Akal Takht at his own expense. The Guru however, declined the offer, saying:

My Sikhs and I shall raise this Throne with the labor of our own little resources. It will be a symbol of my Sikhs service and sacrifice and not a monument to a King's generosity.



There is great significance in Akal Takht being constructed a few paces away from Harimandir Sahib. Akal Takht symbolized Sikh politics while Harimandir Sahib signified universal truths vested in spiritual growth. Politics and Spirituality were blended to put truth in worldly affairs. Guru Hargobind Sahib revealed they were considered limbs of the same body. Harimandar Sahib and Akal Takht Sahib exemplified Miri Piri as institutions and the Guru exemplified the ideal human, the Saint Soldier, who went from one to another using spiritual truths in worldly affairs and using worldly affairs to understand spiritual truths.

Level 2

Step 1

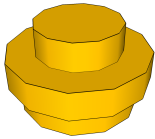

1

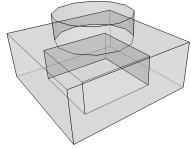

2

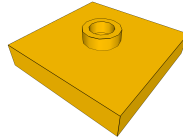

2

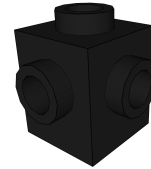

1

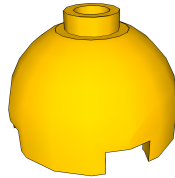

1

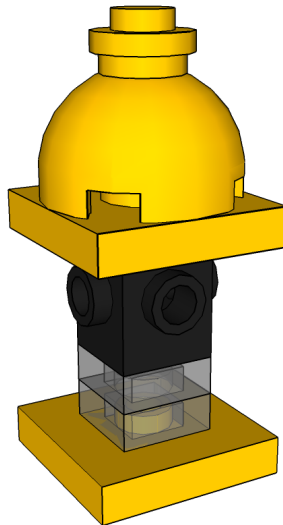

Step 2

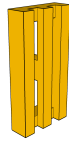

4

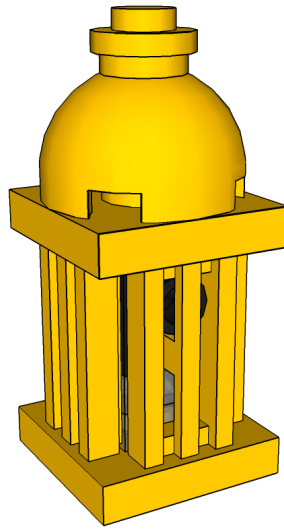

Step 3

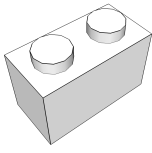

2

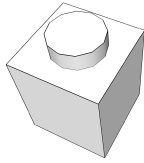

2



4

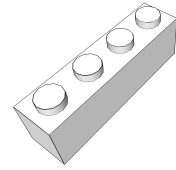

2

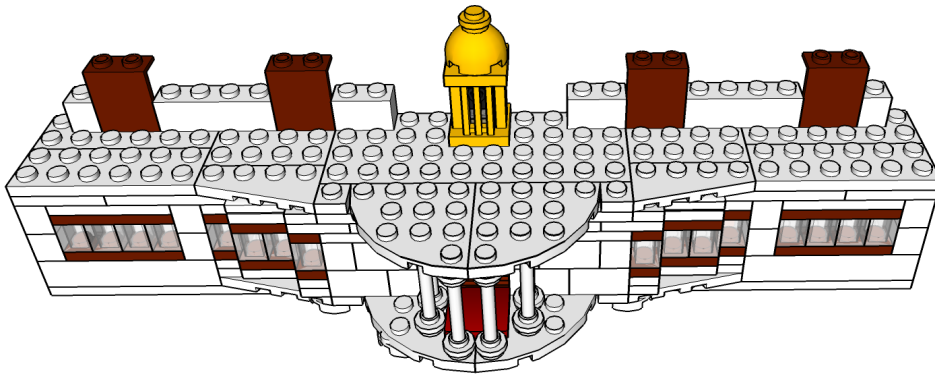

Step 4

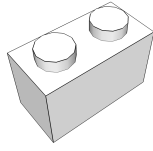

2

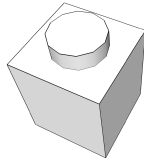

2

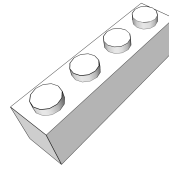

2

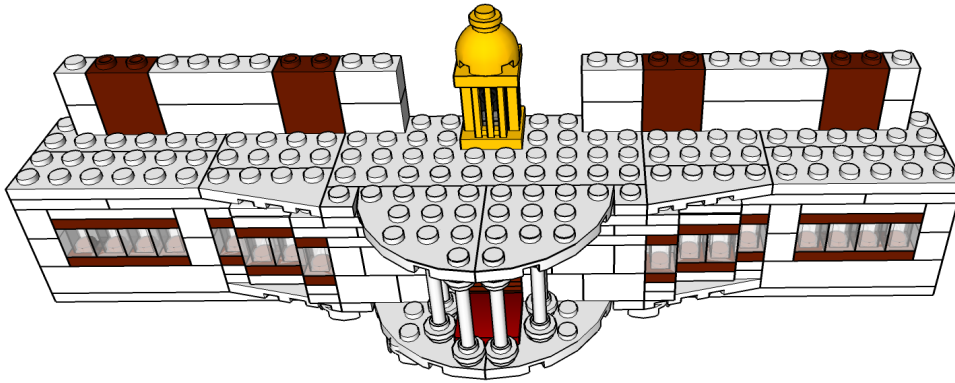

Step 5

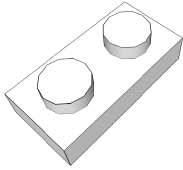

2

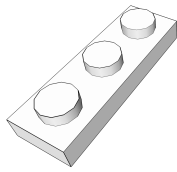

1

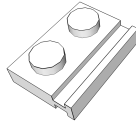

2

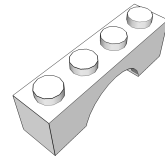

2

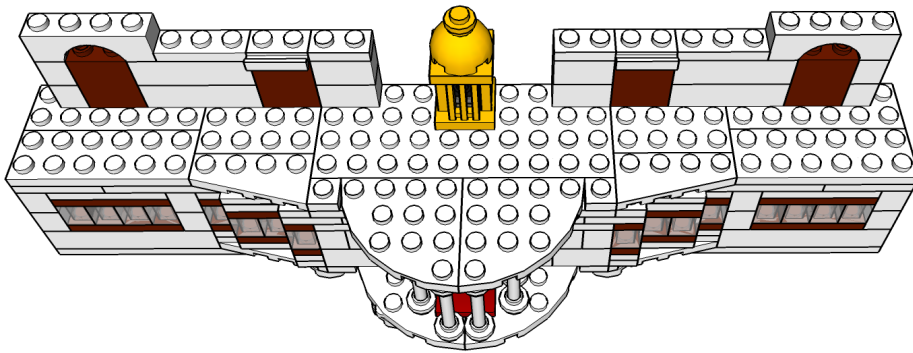

Step 6

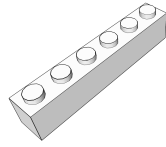

4

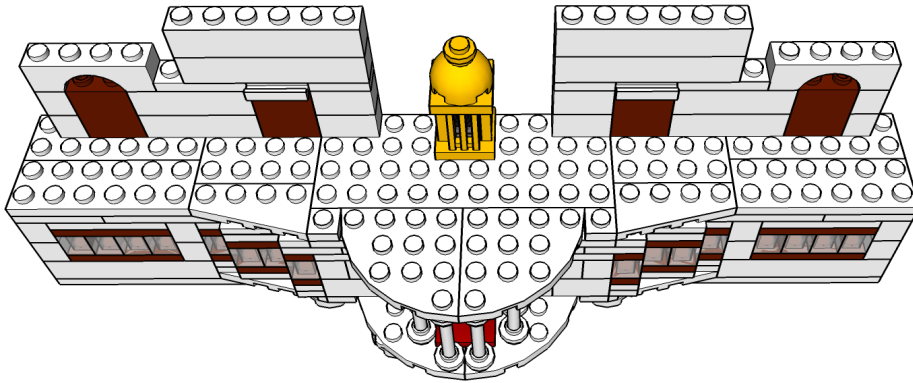

Step 7

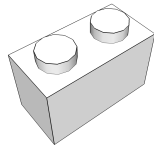

2

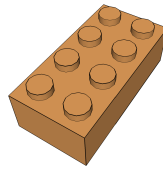

4

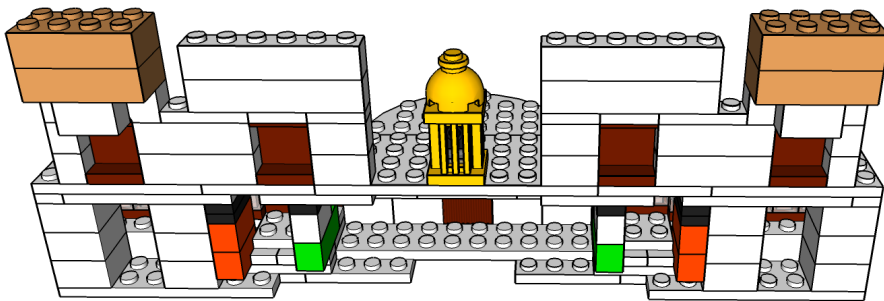

Step 8

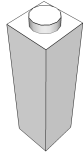

6

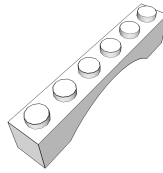

3

Build three

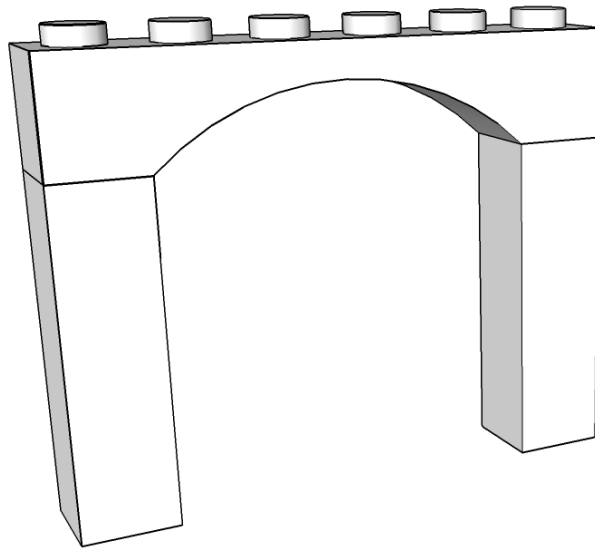

Step 9

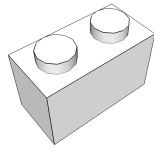

6



3

Build three

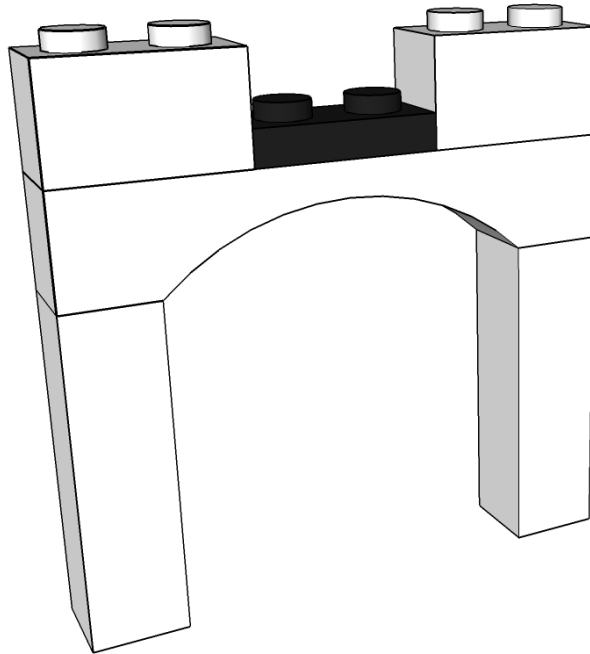

Step 10

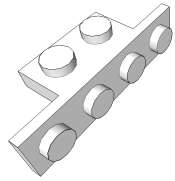

3

Build three

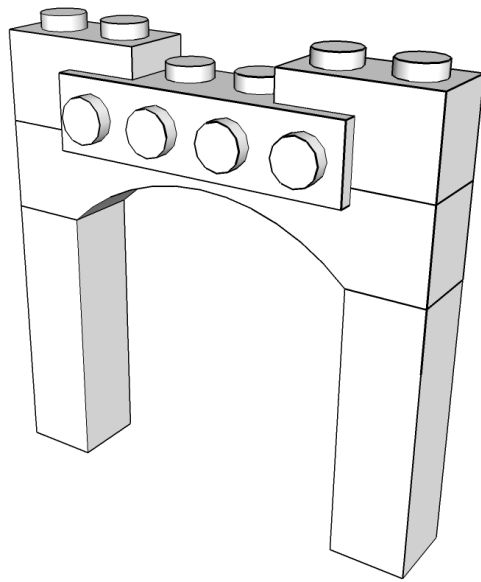

Step 11

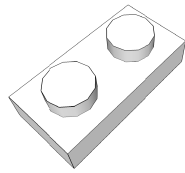

3

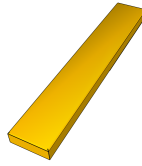

3

Build three

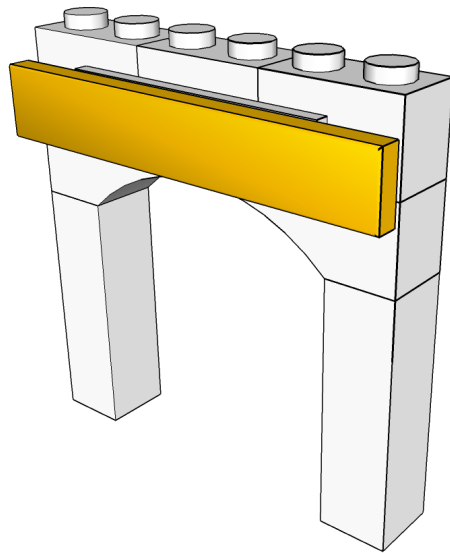

Step 12

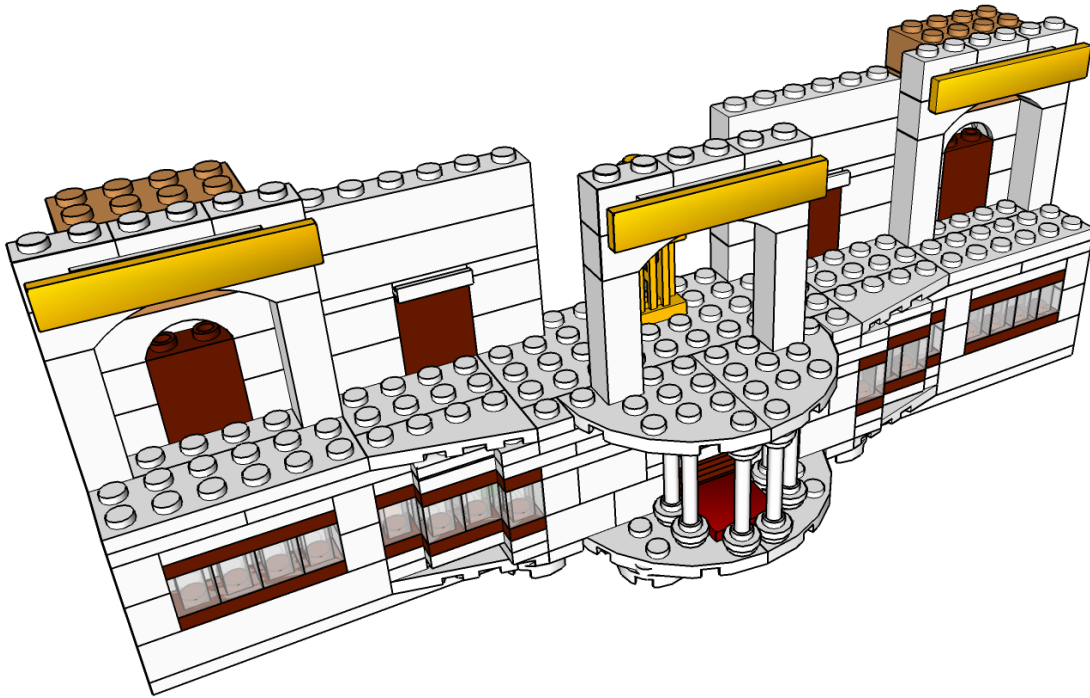

Step 13



4

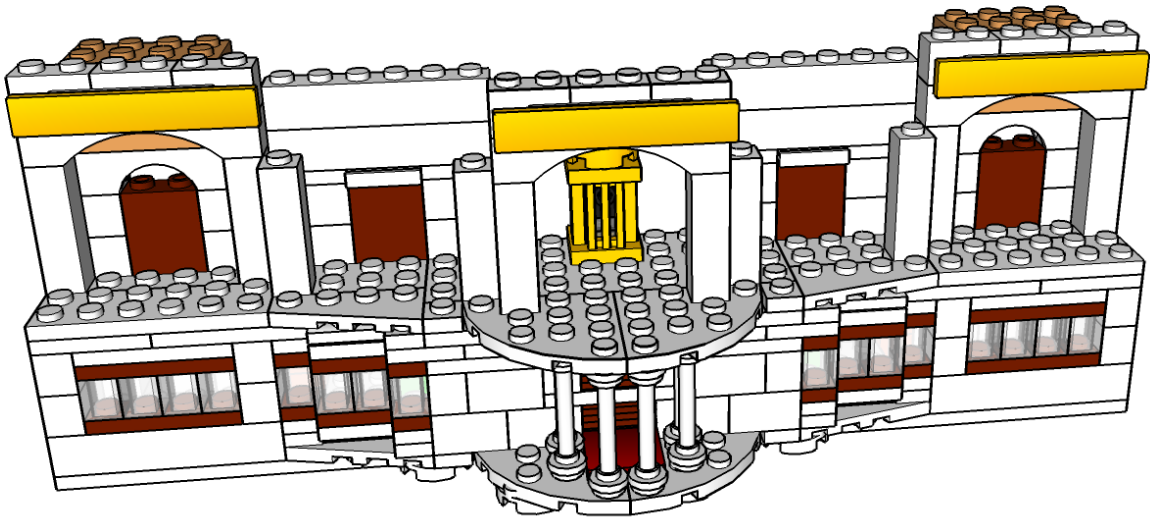

Step 14

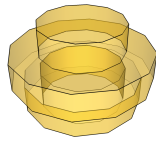

8



2

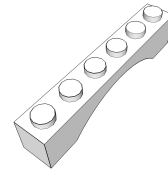

2

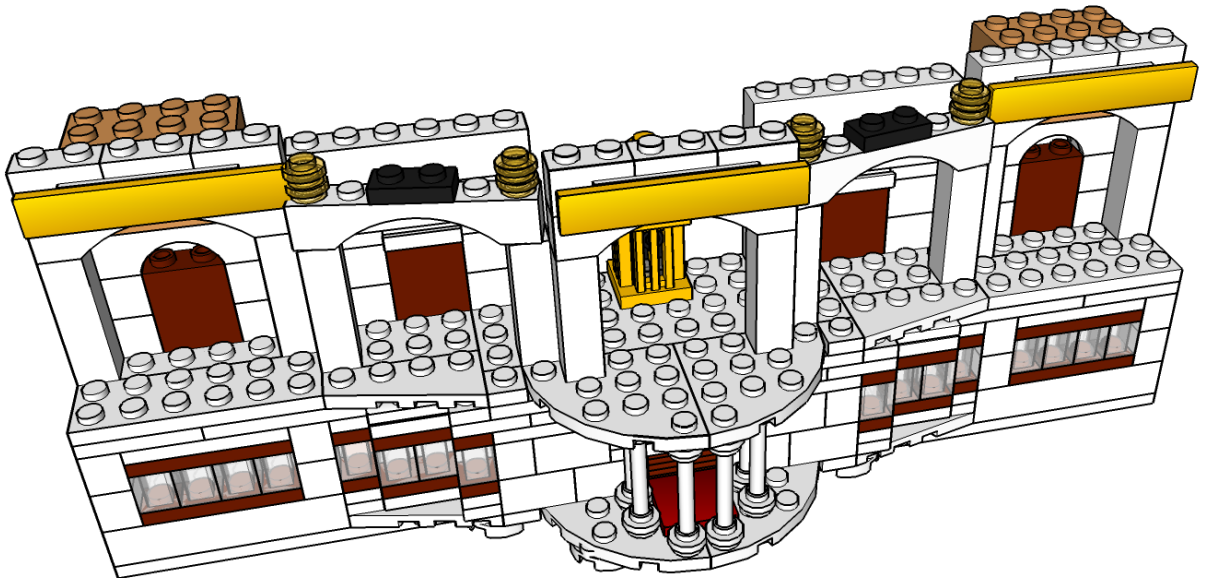

Step 15

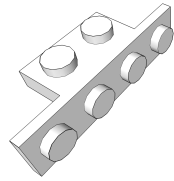

2

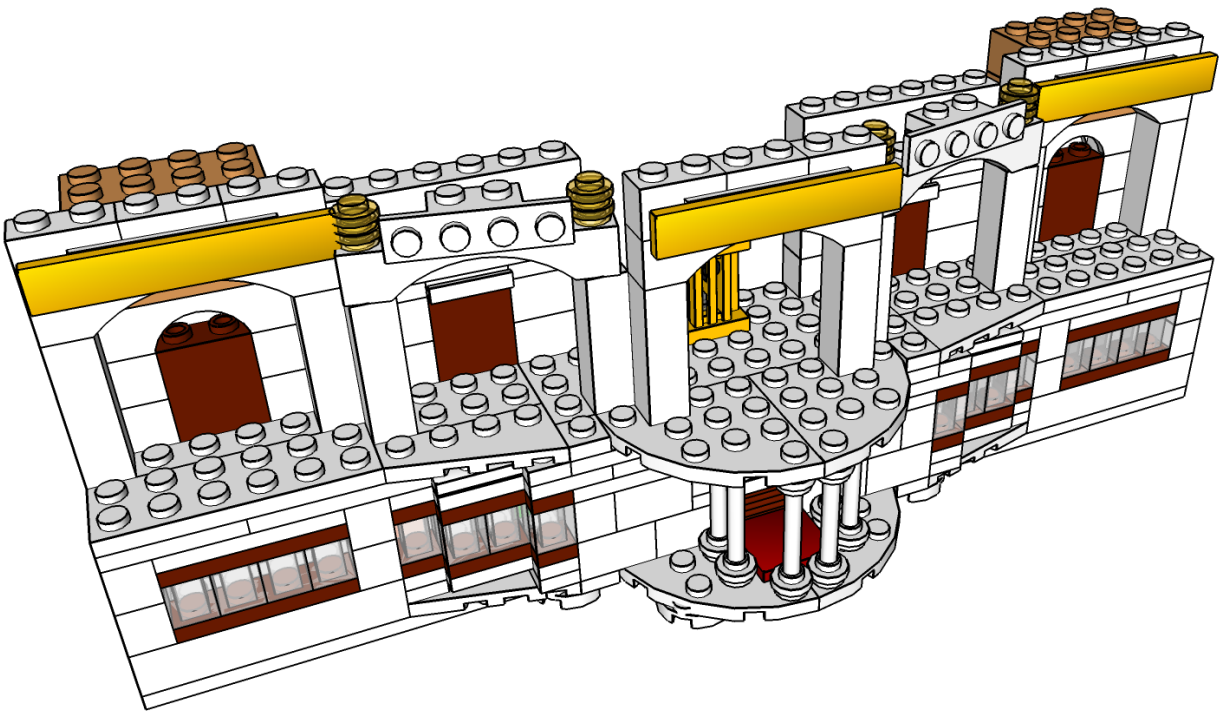

Step 16

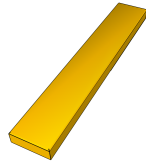

2

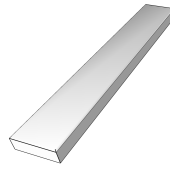

2

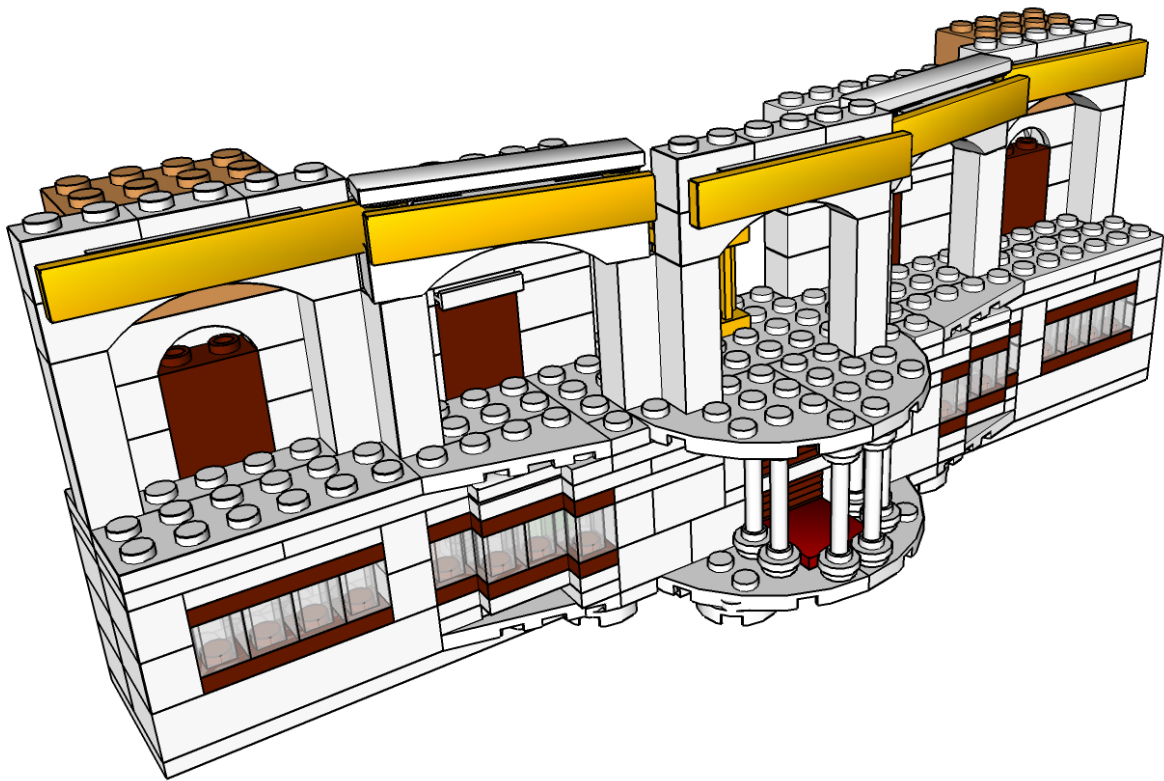

Step 17

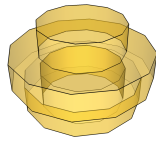

12



2

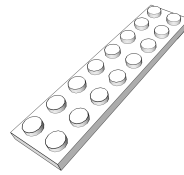

2

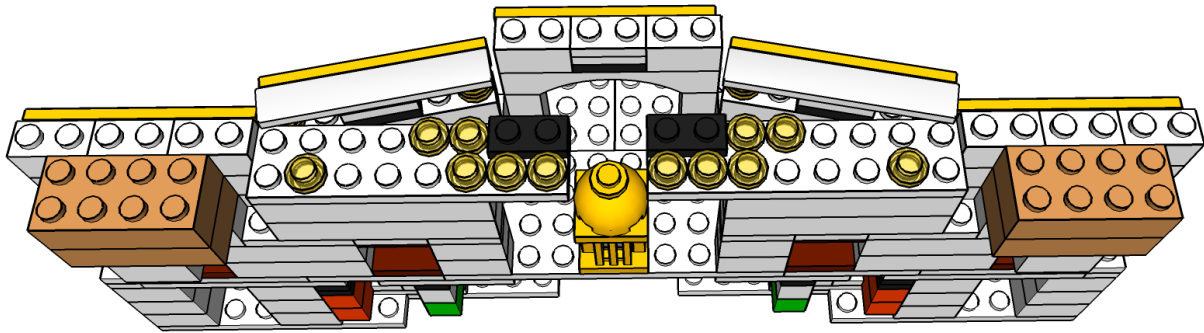

Step 18

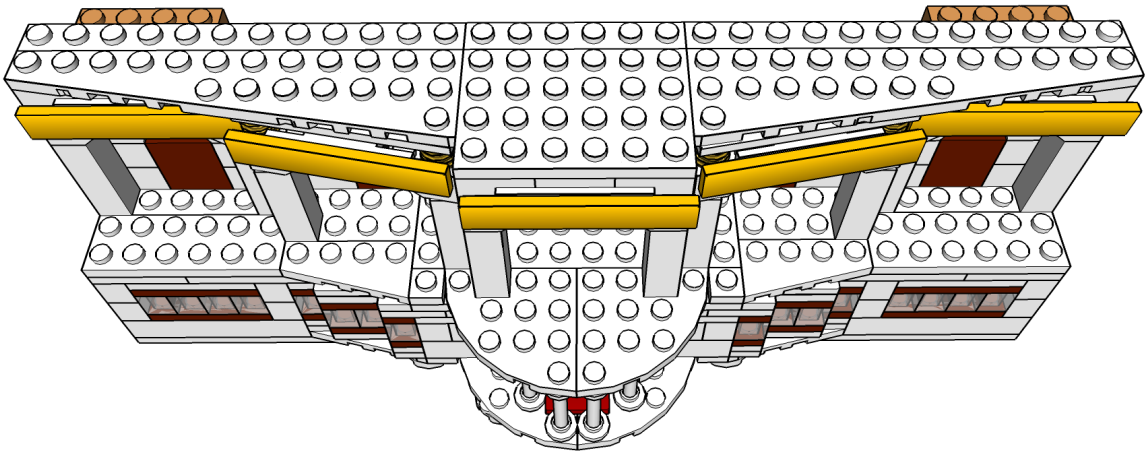
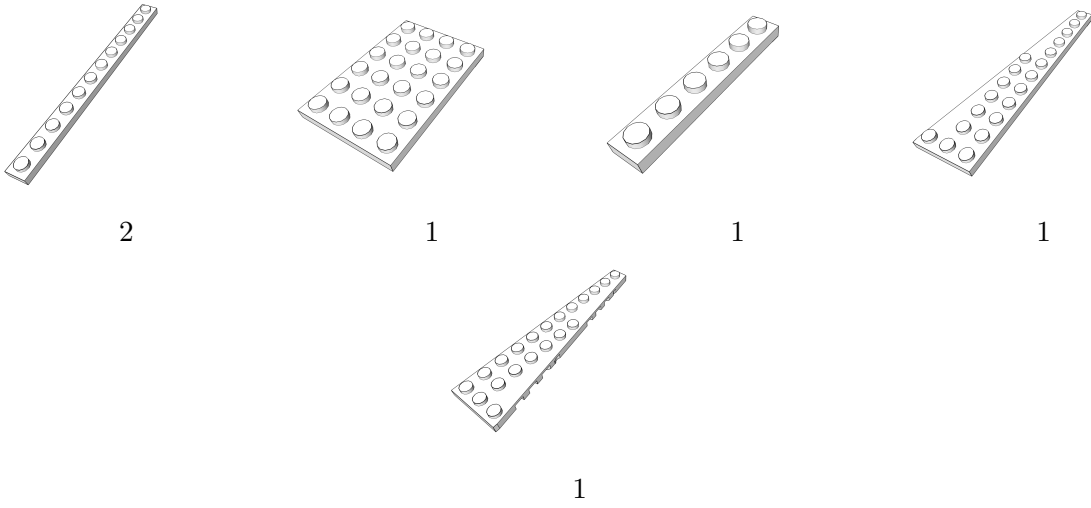

Design

The first level of the present building was constructed in A.D. 1774 during the period of the Sikh Misl. The three upper floors were constructed by Maharaja Ranjit Singh and the domes covered with gilded plates were also built by Ranjit Singh. Later, there was an open-air semi-circular structure built on marble pillars and a gilded interior section. There were also painted wall panels depicting Europeans. The modern building has five floors with marble inlay and a gold-leafed dome. Contemporary restoration work found a layer of paint decorated lime plaster that might have been part of the original structure but later than the time of Harimandir.

Sarbat Khalsa

After the passing of Guru Gobind Singh Ji the Khalsa as a collective began to manage the Guru's worldly mission as Guru Khalsa Panth. The Khalsa was given the status of Guru in 1699 at Vaisakhi. Bhai Kahan Singh Nabha in Mahan Kosh explains:

The Khalsa is the body of the Guru and Gurbani (Guru Granth Sahib Ji) is the essence.

ਖਾਲਸਾ ਗੁਰੂ ਕੀ ਦੇਹ ਹੈ ਅਤੇ ਬਾਣੀ (ਗੁਰੂ ਗ੍ਰੰਥ ਸਾਹਿਬ) ਆਤਮਾ ਹੈ, ਬਾਣੀ ਦੇ ਆਧਾਰ ਵਿਹਾਰ ਪਰਮਾਰਥ ਸਿੱਧ ਕਰਨ ਵਾਲਾ ਪੰਥ ਪੂਰਣ ਗੁਰੂ ਰੂਪ ਹੈ ।
ਬਾਣੀ ਤੋਂ ਸਵਤੰਤਰ ਹੋ ਕੇ ਖਾਲਸਾ ਗੁਰ ਪਦਵੀ ਦਾ ਅਧਿਕਾਰੀ ਨਹੀਂ ਹੈ

Without Gurbani the Khalsa is not entitled to the status of Guru. Dr. Kharak Singh in Guru Panth-Granth further explains:

In the twin doctrine of 'Guru Granth - Guru Panth', the two components have a complementary relationship with a distinct role assigned to each. For effective functioning of body and soul, they have to act together. In practice the doctrine means that the body of the Panth has to take decisions on temporal matters dealing with a situation prevailing at a particular time strictly following the spiritual

principles laid down in Guru Granth Sahib to carry out the will of God or Sarbat Da Bhala.

As such Akal Takht Sahib became the capital building or throne of the Khalsa Panth collectively alongside Guru Granth Sahib. Guru Granth Sahib is absolute sovereign/independent leader of the Sikhs and the Khalsa's job is to protect Guru Granth Sahib, respond to situations/conflicts as the physical arm of the Guru collectively, and create new ideas based on the teachings of Guru Granth Sahib Ji.

In order to collectively organize and make decisions the Khalsa assembled at Akal Takht to conduct a Sarbat Khalsa (literally all Khalsa assembly). The Sarbat Khalsa is a unique democratic Sikh system of democracy based on consensus (common minimum program) as opposed to western majority rules democracy.

There have been many times in Sikh history where the Khalsa has not had access to Akal Takht Sahib due to corruption or malicious government forces. During these times the Khalsa would conduct a Sarbat Khalsa in places they could freely meet without outside interference.

Ordinarily the Khalsa proposed to meet at Akal Takht twice a year during the Baisakhi and Diwali festivals which were the opportune times for such meetings when farmers were able to leave their crops unattended. On the occasions of the fairs and festivals the Sarbat Khalsa would discuss the problems that confronted the Sikh Nation. The Khalsa would also call emergency Sarbat Khalsa's to discuss topics of immense political importance or understand out to counter an imminent danger to any innocent people. One example of Sarbat Khalsa: When Tara Singh Van was killed in 1726 along with his companions (the entire sangat managing Darbar Sahib), the Sikhs met at Akal Takht and decided to declare war against the government by destabilizing it.

According to John Malcolm,

When the chiefs meet upon this solemn occasion, it is concluded that all private animosities cease and that every man sacrifices his personal feelings at the shrine of general good and actuated by the principles of pure patriotism thinks of nothing but the interests of the religion and commonwealth to which he belongs.

Thus sitting in front of Guru Granth Sahib at Akal Takht, they proceeded to consider the danger with which they were threatened. They settled their plans and strategy for averting the danger and chose the generals who were to lead their armies against the offenders.

As the Sikh Sardars held Akal Takht in high esteem the decisions taken there had a moral and religious binding on them. The Sardars could not, therefore, afford to go against the decisions taken at Akal Takht, and run the risk of losing their popularity with the community. Though the Sardars, at times, quarreled among themselves, all was peace and friendship when they met at Akal Takht because it was not about their personal wants it was about the Khalsa and the Guru.

At the time of their meeting, they assembled in the open space in front of Akal Takht. Each Sardar had his companions sitting behind him and he participated in the deliberations on behalf of his men. If the followers had any point to make, they did it through their Sardar or they could do it direct. It was not Sardars' assembly nor where the deliberations of the national problems the monopoly of the chiefs. But it was a gathering of the community. According to Fauja Singh, in the assembly at Akal Takht the basic ideas kept before them by its members were those of equality, unanimity and responsibility. The idea of equality and principles of Sangat from Guru Granth Sahib entitled every member of the Nation, including women, to attend and participate in the discussions. The right of participation in discussions had to be exercised personally and directly and not through elected or nominated representatives. The principle of unanimity was based on the belief that the Khalsa was the embodiment of the Holy Guru and that all their assemblies were made Sanctimonious by the Guru's presence in them. Therefore, all collective deliberations were conducted in a detached manner. Different viewpoints could be expressed but as they were bound by a solemn pledge of being united in the presence of the Guru, the resolutions were passed only unanimously.

The councils of the Sarbat Khalsa meeting at Akal Takht had a variety of problems for their deliberations. It was there that the Sarbat Khalsa selected the Jathedar or the chief leader of the Dal Khalsa. They also chose agents who were entrusted with powers to negotiate with others on behalf of the Sikh Nation. Sometimes cases of disputed successions were brought up for its verdict as Sarbat Khalsa acted as a judicial body. At Sarbat Khalsa they also took measures for the spread of the Sikh faith and the management of the Gurudwaras.

Throughout the 18th century, Akal Takht was the hub of the Sikh politics and it gave direction to the activities of the people through resolutions passed there.

The assembly of the Sikh chiefs at Akal Takht cannot be called the Central Government of the Sikh Misl. This assembly had no political jurisdiction or military sanction over the individual chiefs, nor was it necessary. Their attendance was not compulsory but the chiefs considered it obligatory to attend specially with a view to promoting their own interests. Although there existed no means to enforce an obedience to the Gurmatta passed at Akal Takht, yet there was never an occasion known when such a decision was flouted. The decisions taken in the presence of Guru Granth Sahib had behind them the Gurus sanction which was greater in force than that of any power of Earth. The Sikhs obeyed the decisions of Akal Takht even at the cost of their lives. The simple practice and moral authority of the Akal Takht were sufficient to preserve the Khalsa in the troublous times in the 18th century and beyond.

When the situation on all fronts eased, the Sikh chiefs became a little indifferent to attend the meetings of the Sarbat Khalsa at Akal Takht. Now their meetings were attended only by a few chiefs. But the absentees never meant any opposition to such meetings or any resistance to decisions taken there. Being busy in their internal affairs, the Sardars, sometimes, just could not attend. There was absolutely no such thing as intentional breaking away of the Sardars from Akal Takht with a calculated design to weaken this seat of authority. With the rise of Ranjit Singh as a sovereign ruler, the Punjab came to be consolidated and the foreign invaders ceased to endanger the country and the community. So during Ranjit Singh's period the rule of Akal Takht fell into disuse so far as political affairs were concerned. Nobody could be above the decisions taken at this place, not even the great Maharaja. The predominant opinion is that Ranjit Singh paid his homage to Akal Takht not simply as a force which he could not afford to ignore but as the ultimate source of strength and stability to the state he was engaged to build. Others have the opinion Ranjit Singh maliciously took steps to ensure the democratic structure of Sarbat Khalsa was not used anymore in order to stay in power.

Level 3

Step 1

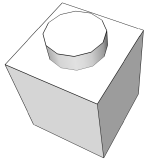

2



5

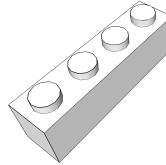

2

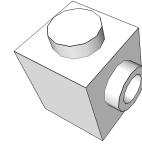

2

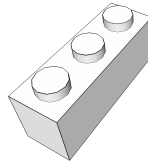

2

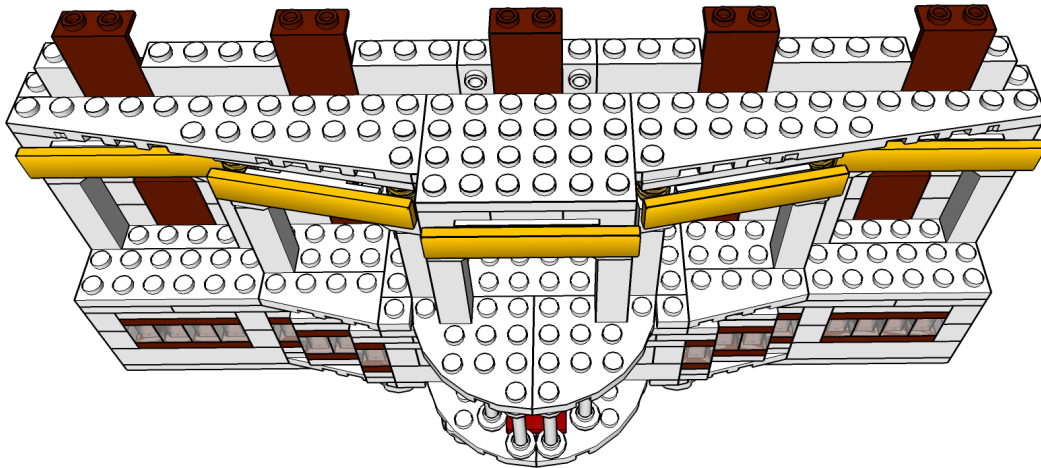

Step 2

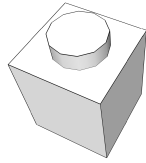

2

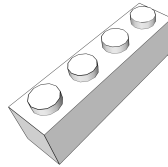

4

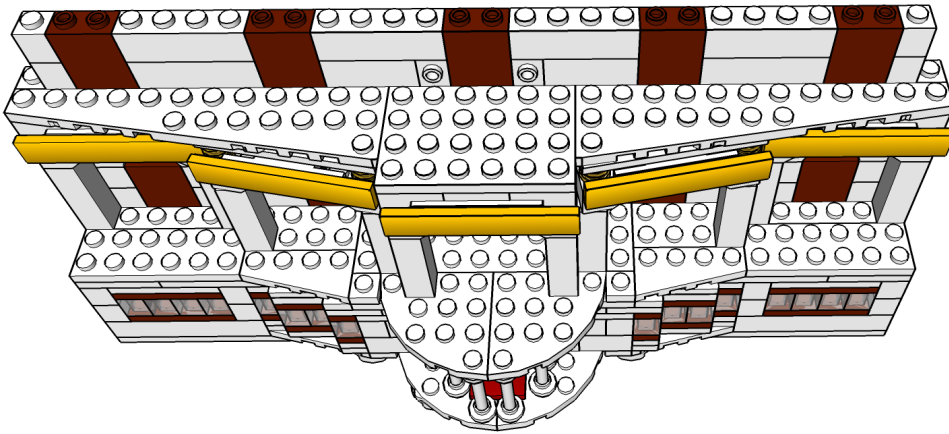

Step 3

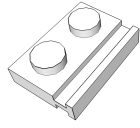

3

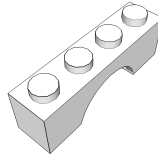

2

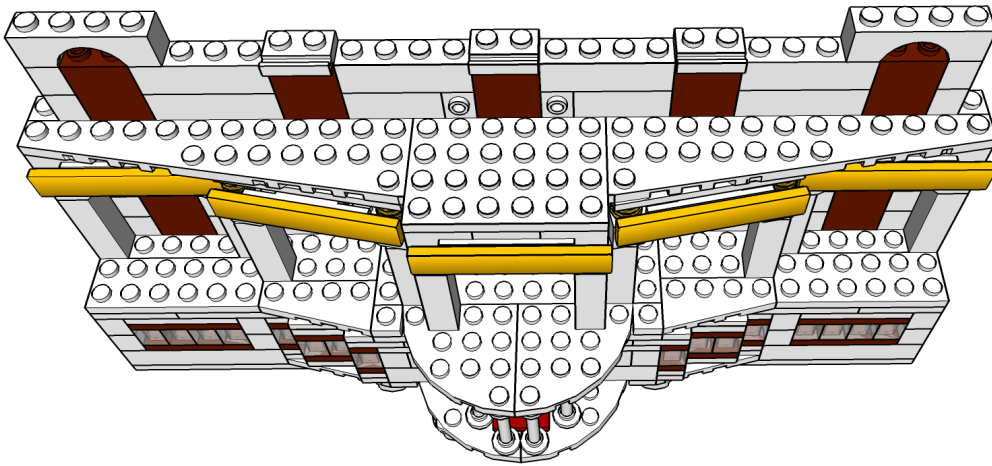

Step 4

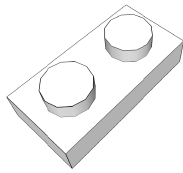

4

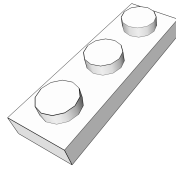

2



2

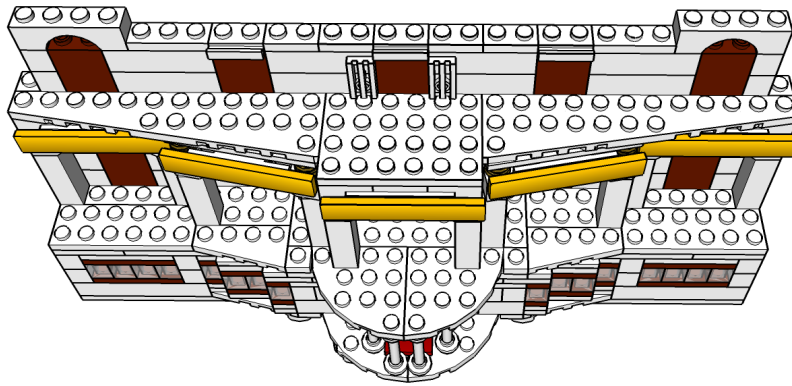

Step 5

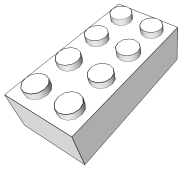

4

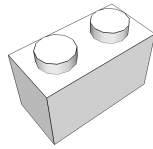

2

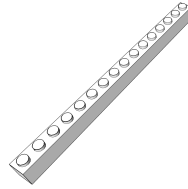

2

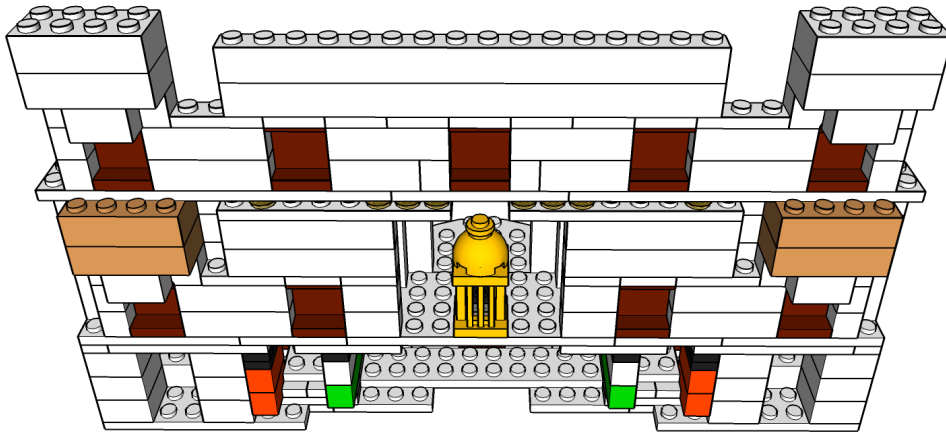

Step 6

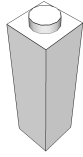

6

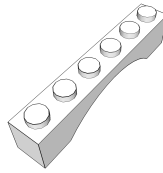

3

Build Three

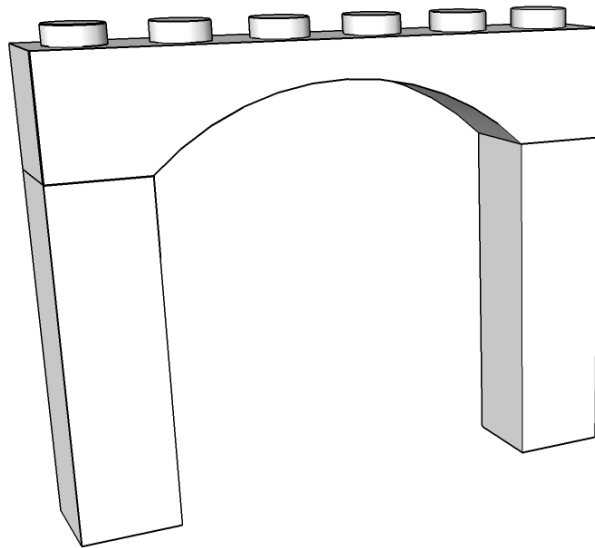

Step 7

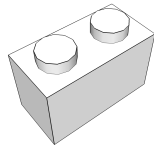

6



3

Build Three

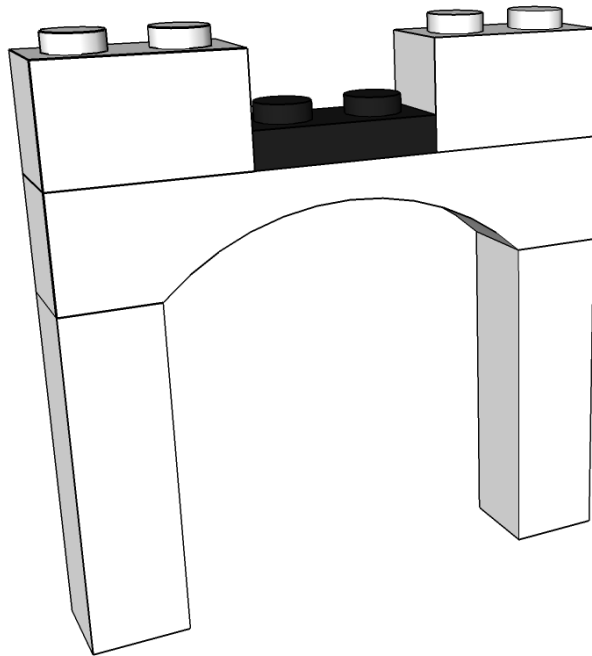

Step 8

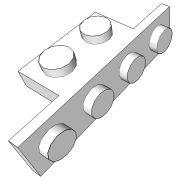

3

Build Three

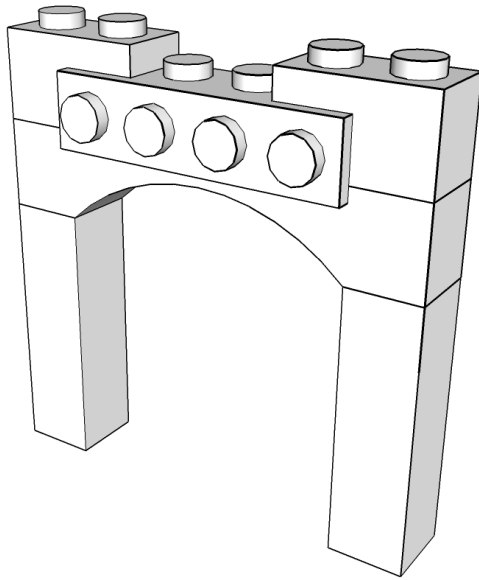

Step 9

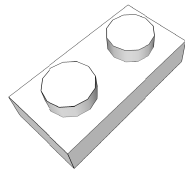

3

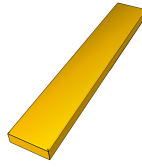

3

Build Three

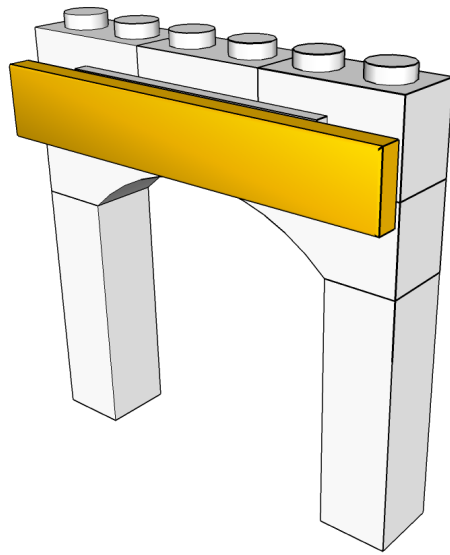

Step 10

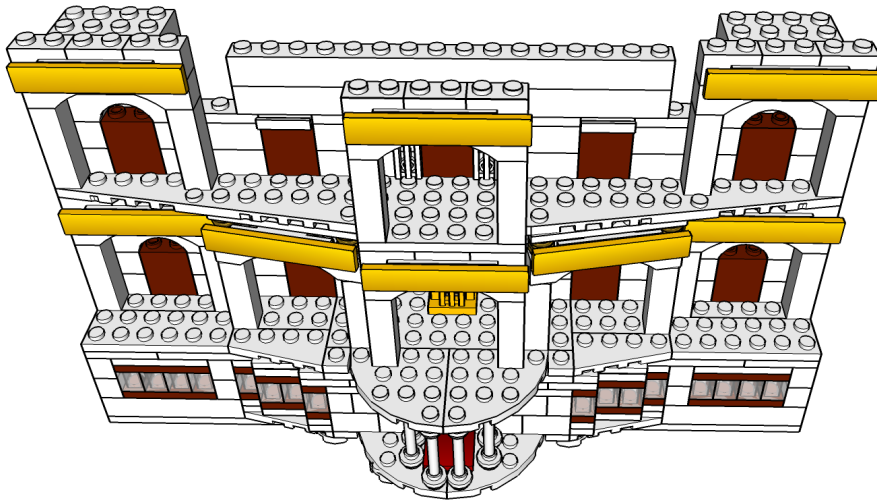

Step 11

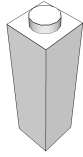

4

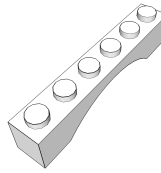

2

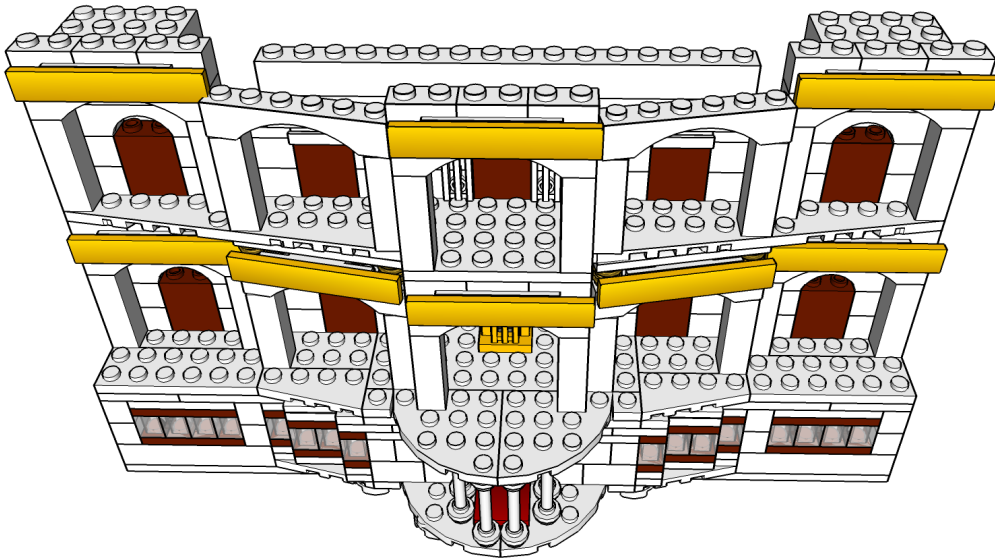

Step 12

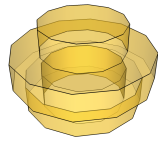

8



2

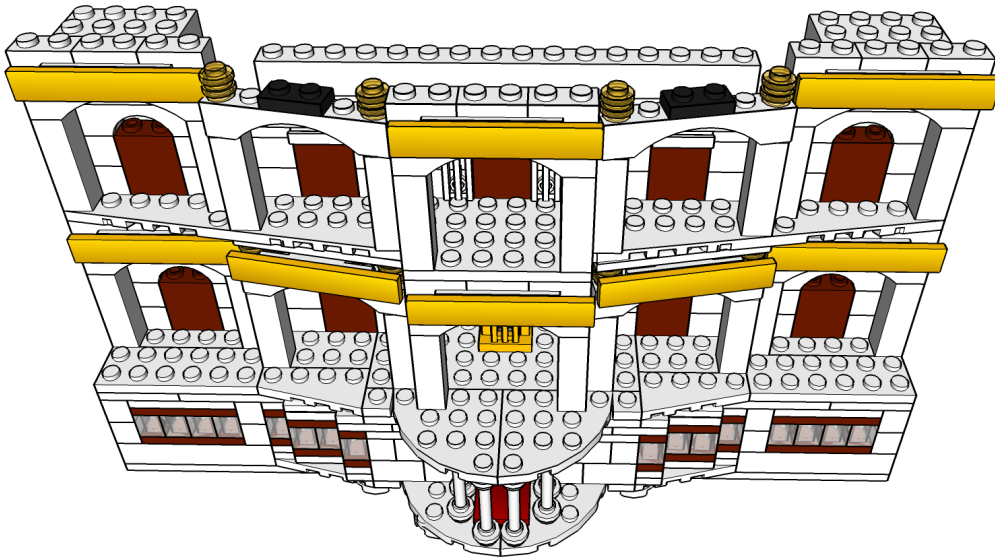

Step 13

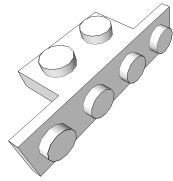

2

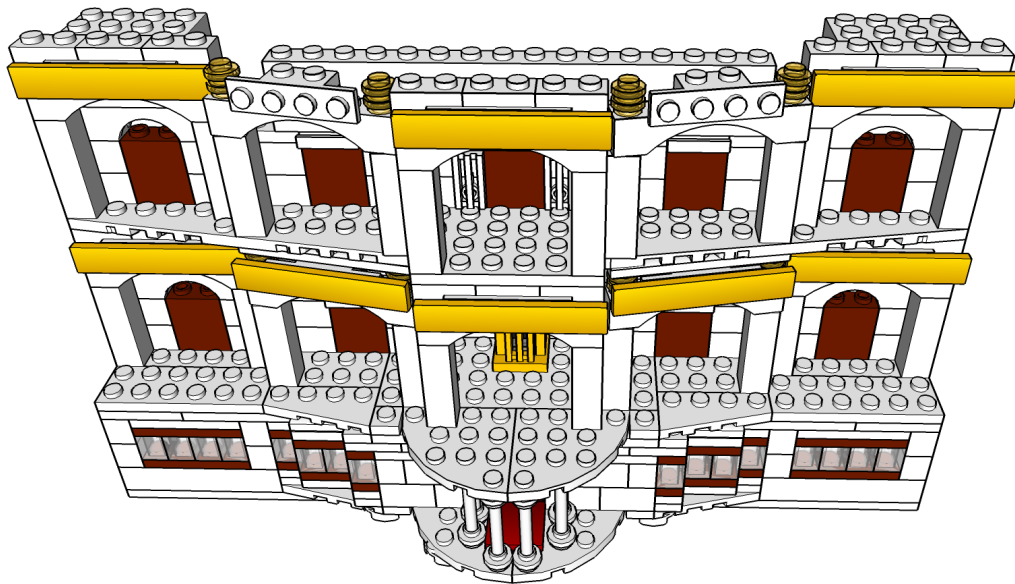

Step 14

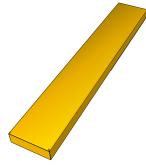

2

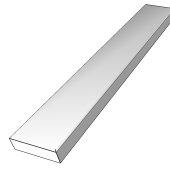

2

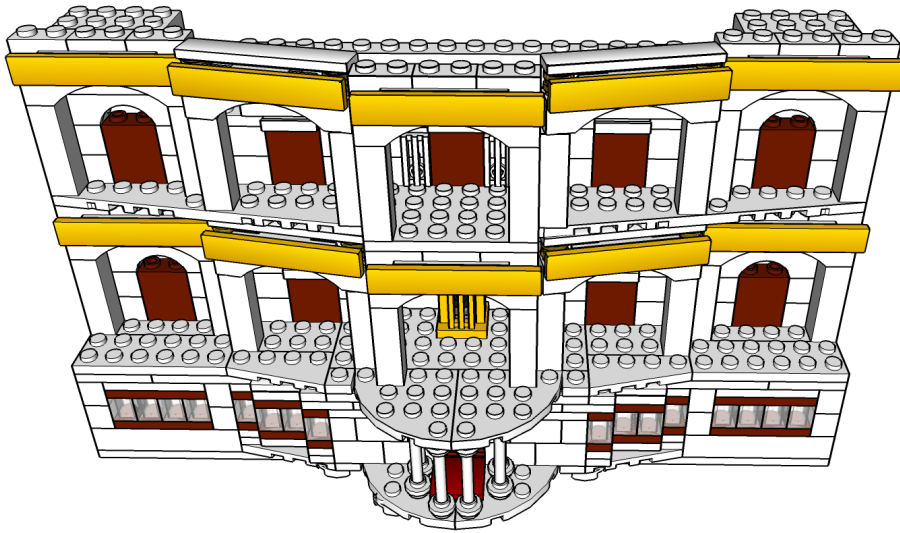

Step 15

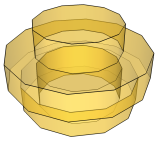

12



2

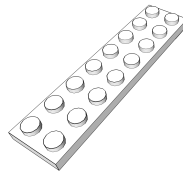

2

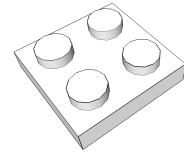

1

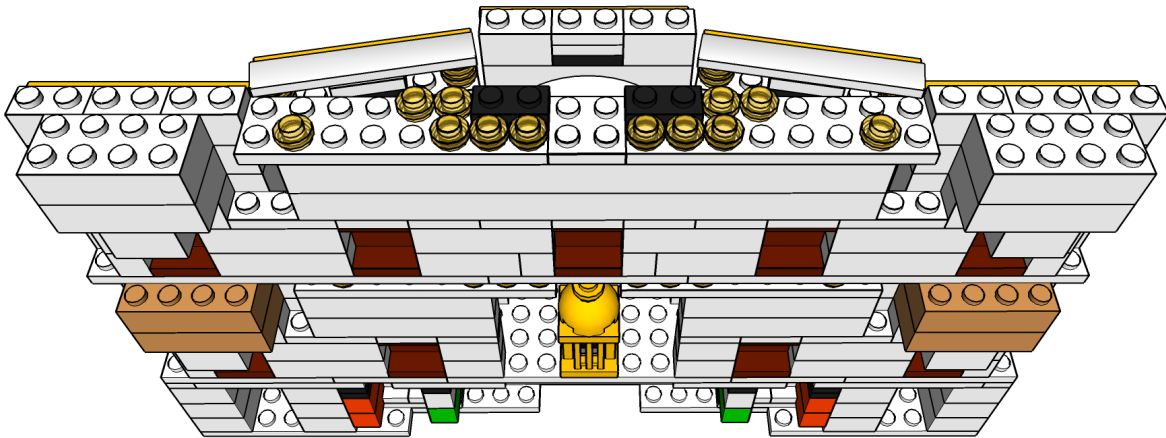

Step 16

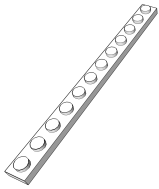

2

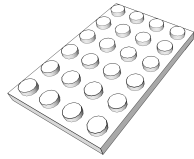

1

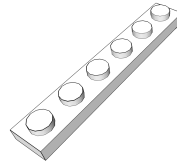

1

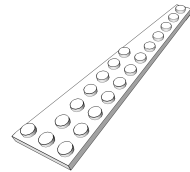

1

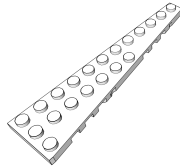

1

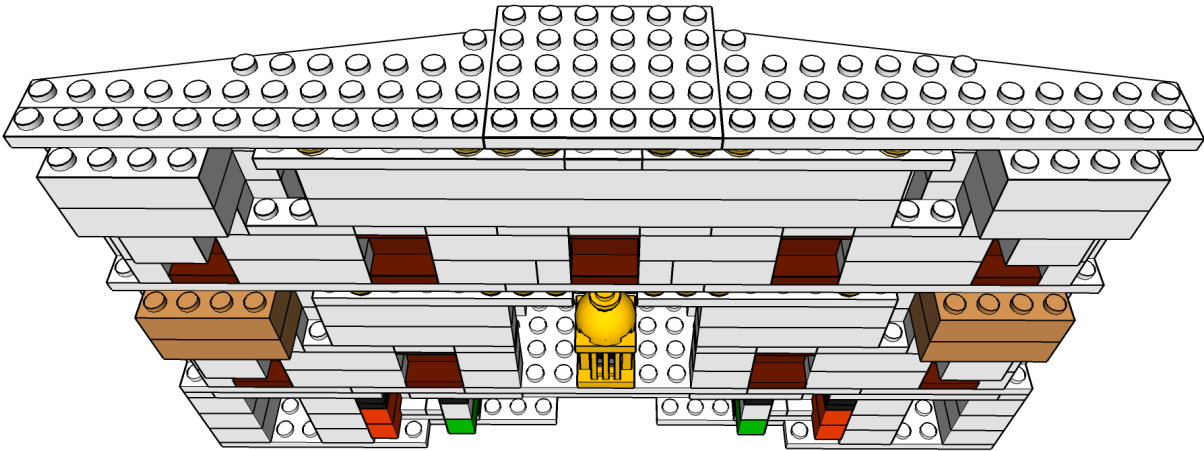

The Paradigm

The Muslim forces of the foreign invaders, and Hindu and Muslim armies of the Mughal Government ruined Akal Takht many a time as in the case of Harimandir Sahib because it stood for distinct Sikh sovereignty beyond their governments and political power. In the 18th century, Ahmed Shah Abdali and Massa Rangar led a series of attacks on the Akal Takht and Harimandir Sahib. When the British annexed the Sikh Empire the first thing they did was take control of Akal Takht Sahib and slowly plant their agents in all Sikh institutions while at the sametime rewriting the Sikh education system so that it taught nothing about Akal Takht Sahib and the Sikh systems of government. During the freedom movement of India the Khalsa retook control of Akal Takht Sahib and other Sikh Institutions and used them as organization centers to agitate against British occupation of Panjab. In the 1970s the Khalsa started the movement to save the Punjabi language (Punjabi Soba Moorcha) when the government of India betrayed the Sikhs by systematically trying to eliminate the Punjabi language as the legal language of Panjab. In 1982 the Dharam Yudh Morcha (movement for implementation of the Anandpur Sahib Resultion: a list of Sikh demands to the Indian State) started at Akal Takht Sahib which the Indian Government did not give but instead they sent an army to attack Panjab on June 4th 1984. The army attacked over 40 Gurudwara's across Panjab that were used as organization hubs for Dharam Yudh Moorcha. Darbar Sahib the headquarters of the entire movement was also attacked in which Akal Takht Sahib was partially destroyed in what the Indian Army calls Operation Bluestar, the Khalsa remembers the day as the Battle of Amritsar and it deems those who defended Darbar Sahib martyrs of the Sikh Nation.

In the past, the Akal Takht was a venue for political and secular deliberations of the Sikh community. Today, the Akal Takht issues decrees that affect Sikhs around the world without any Sarbat Khalsa. Over time, Sikhs have become separated from their own institutions and unique Gurbani centered systems (like Sarbat Khalsa). This has given rise to a generation of Khalsa who are disempowered, disenfranchised and disconnected from the very sense of oneness vested in the Khalsa. Today, the institution of the Akal Takht itself is enslaved by corruption and nepotism.

Re-establishing the “Immortal Throne” will return our governing institutions to practicing the transcendental doctrines of love and justice, bowing to no other master, following no other system of thought, and answering only to the Guru Granth-Panth. Then and only then will Akal Takht Sahib return to its unifying role of engaging all Sikhs in the service of humanity and truth.

Level 4

Step 1

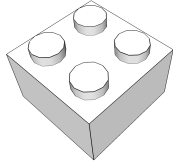

5

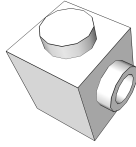

2

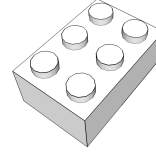

2

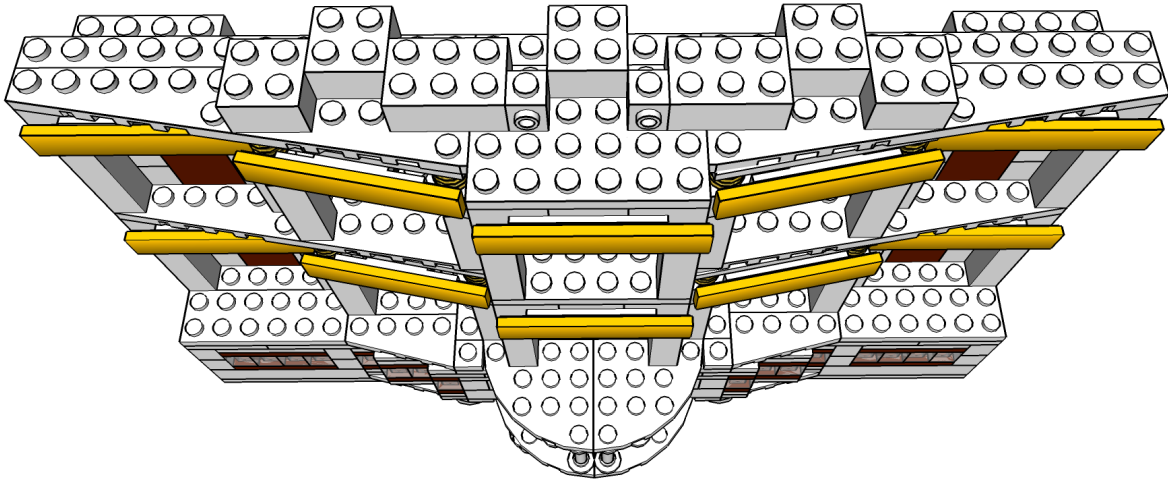

Step 2



3

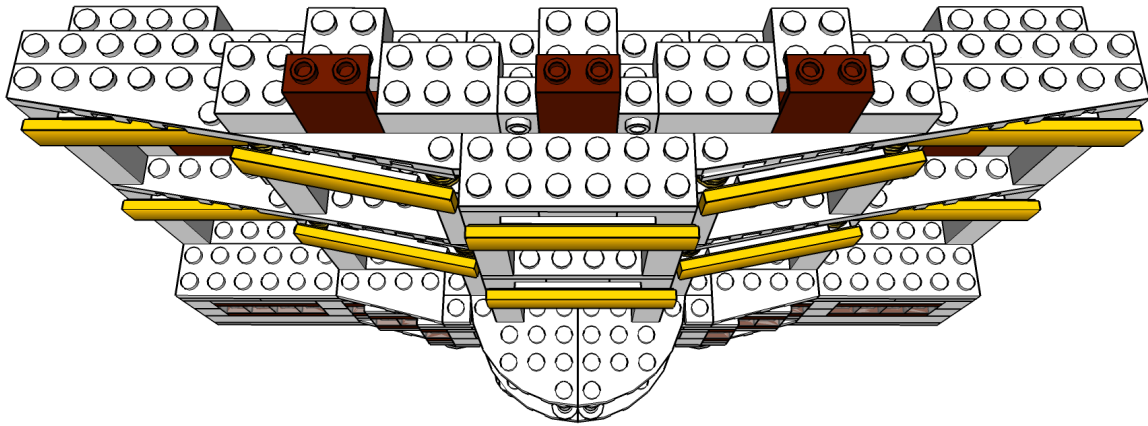

Step 3

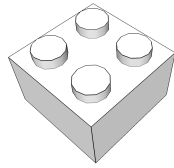

5

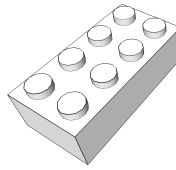

2

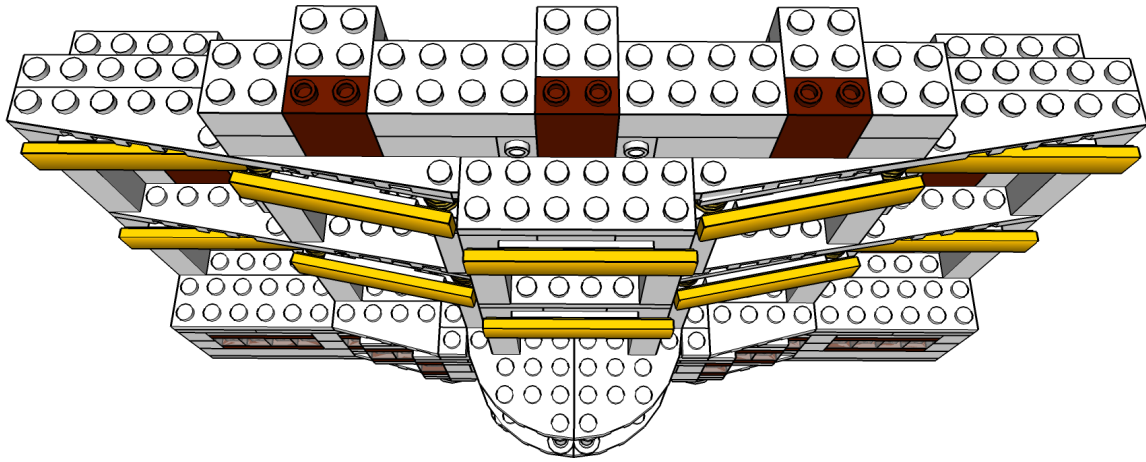

Step 4

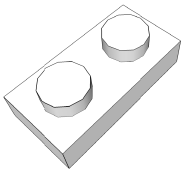

2

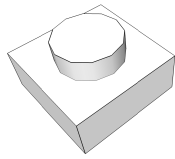

2

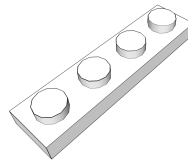

2

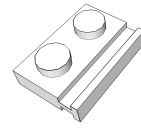

3

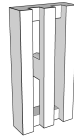

2

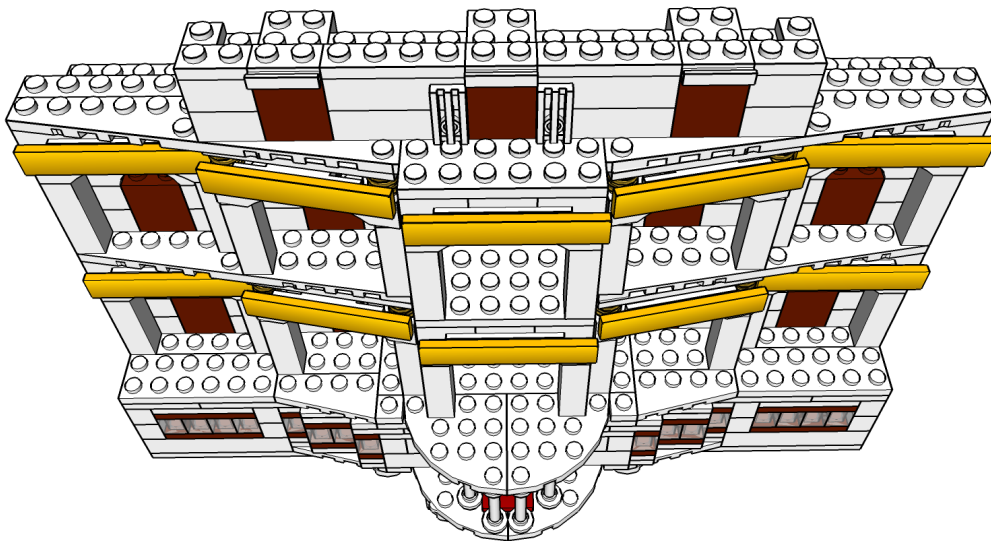

Step 5

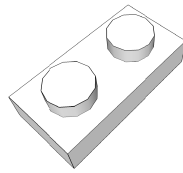

5

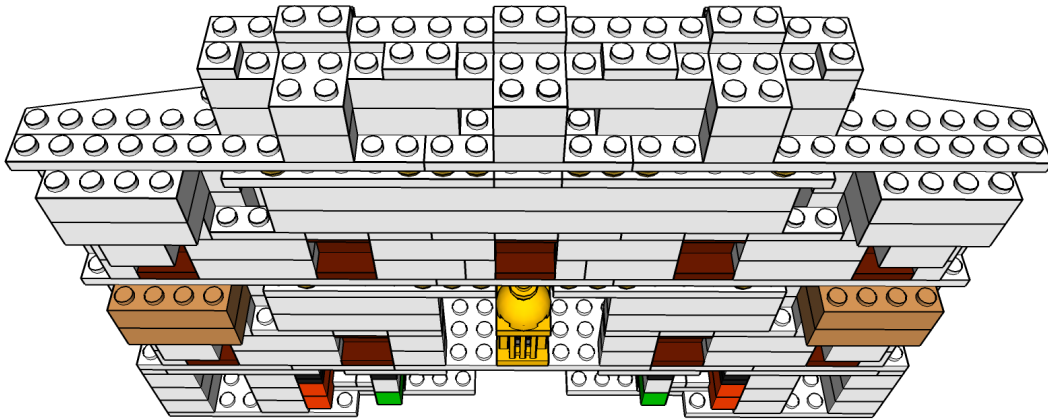

Step 6

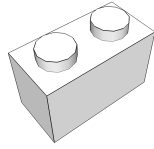

2

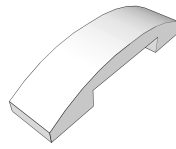

3

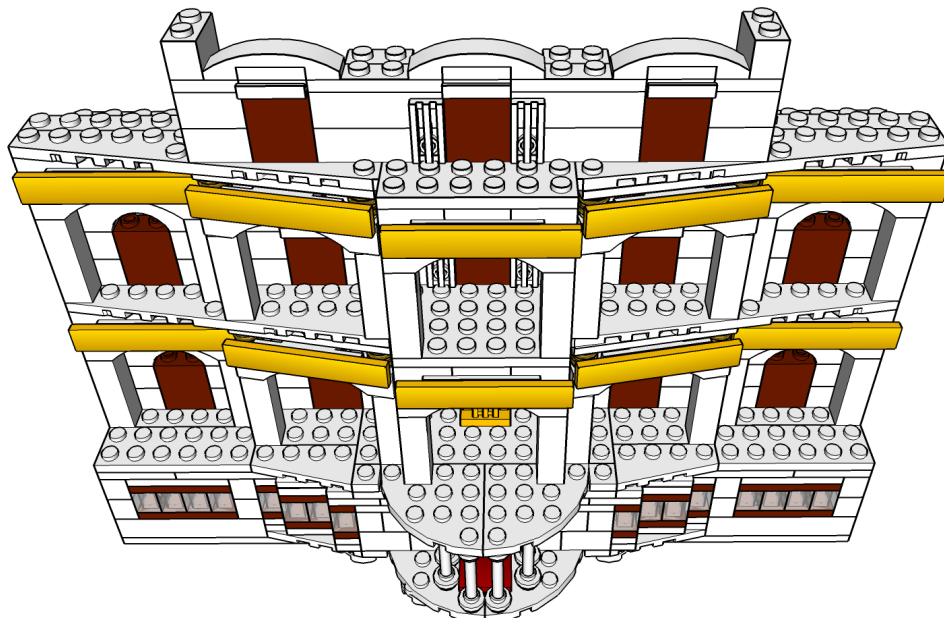

Step 7

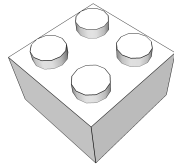

2

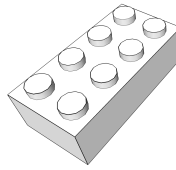

3



Step 8



3

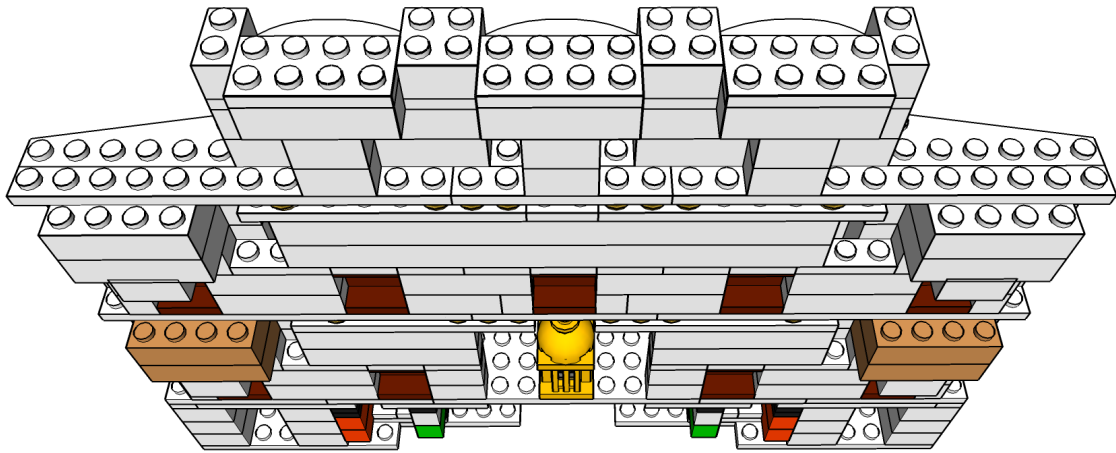

Step 9

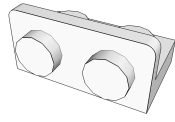

3



1

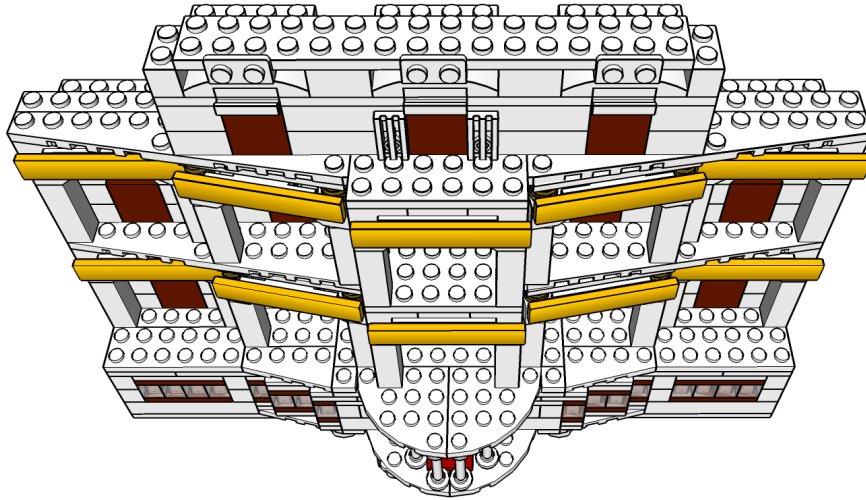

Step 10

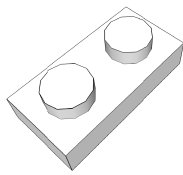

3

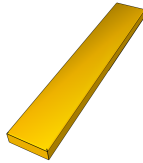

3

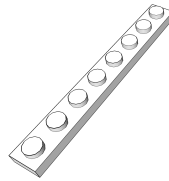

2

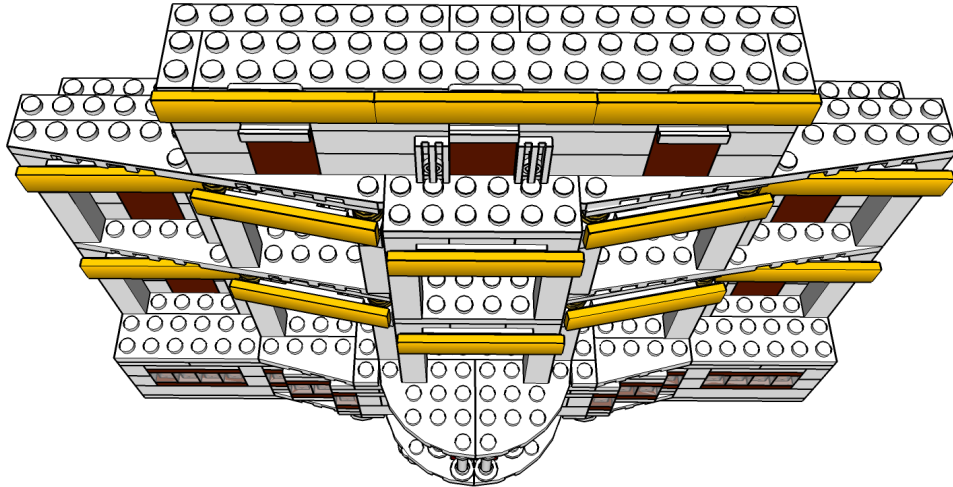

List of Artifacts Contained at the Akhal Takhat

Weapons of the Gurus and their prominent warriors have been preserved in the Akhal Takht. Some of the weapons and arms include the Mini and Piri swords of Guru Hargobind, a sword of Guru Gobind Singh, daggers of Sahibzada Ajit Singh and Sahibzada Jhujhar Singh, Bachittar Singh's sword (weighing ten kilos), the double - edged swords of Baba Deep Singh and Gurbakhsh Singh and Guru Gobind Singh's two gold-tipped arrows. The holy relics of Guru Gobind Singh brought from England-two spears, one sword and one shield-are also kept at Akhal Takht and displayed on a beautifully decorated mount.

- Sri Sahibs (swords) of
 - Guru Hargobind Sahib that represented Miri and Piri
 - Guru Gobind Singh Ji
 - Baba Buddha Ji
 - Jaetha Ji
 - Baba Karam Singh Ji Shaheed
 - Bhai Uday Singh Ji, who was with Guru Gobind Singh Ji
 - Bhai Bidhi Chand Ji
- Dudhara Khanda (double-edged sword) of
 - Baba Gurbakash Singh Ji Shaheed
 - Baba Deep Singh Ji
 - Baba Nodh Singh Ji Shaheed
 - Khadag - Bhai Vachitar Singh Ji, weighing 10 kg
- Guru Hargobinds Sahib's:

- “Guraj” weighing 16 saer. It was given to Dharamvir Jassa Singh by Matta Sundari
- “Katar” A sword like weapon
- Kirpan
- Paeshkabaj
- Katar Baba Ajit Singh’s Katar
- Baba Jujhar Singh’s Katar
- Baba Deep Singh’s:
 - Paeshkabaj
 - A sword like weapon
 - Pistol
 - Medium sized Khanda
 - Two kirpans
 - Two small Khandas
 - Chakar
 - Small Chakar
 - Chakar for head decoration
- Two arrows of Guru Gobind Singh each containing one Toala of gold

Level 5

Step 1

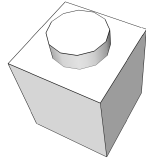

2

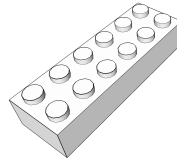

1

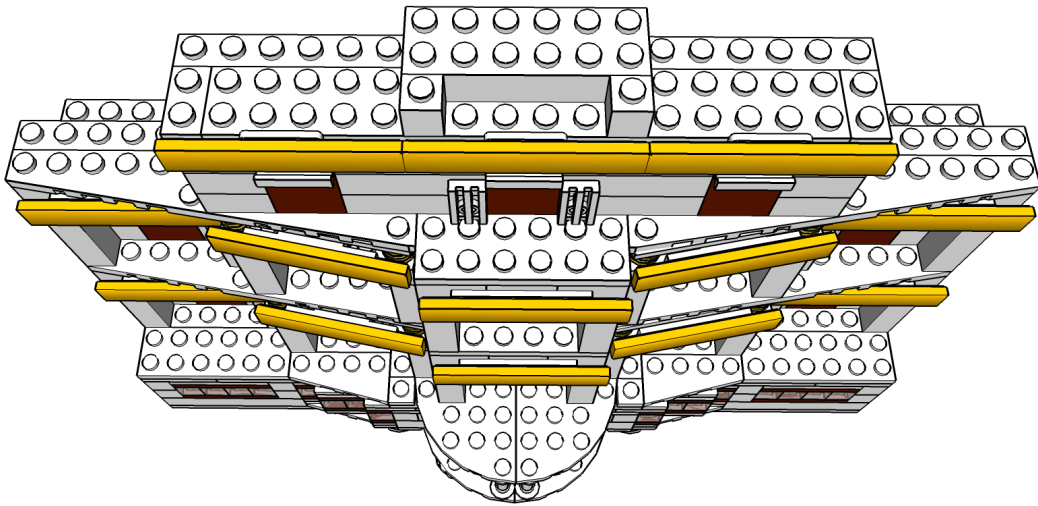

Step 2

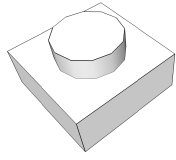

2

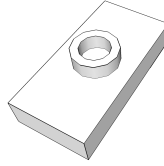

1

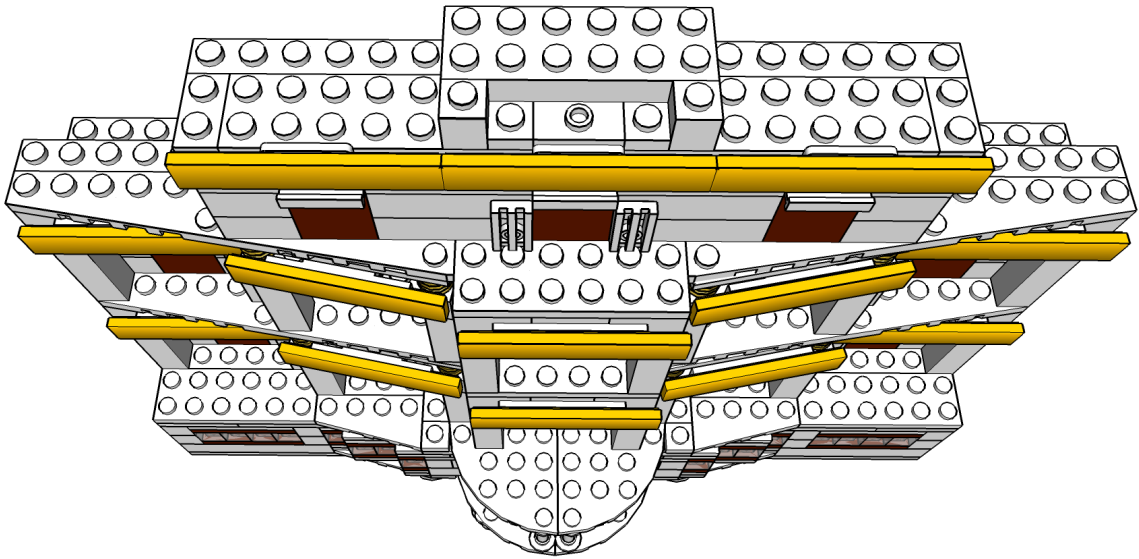

Step 3

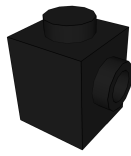

3

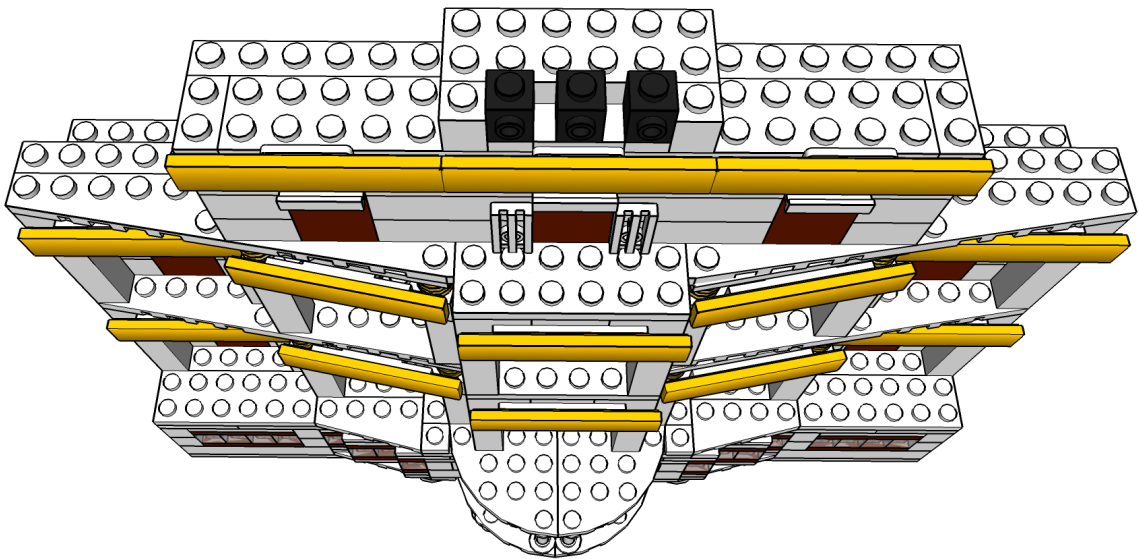

Step 4

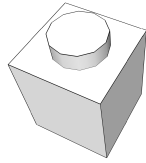

2

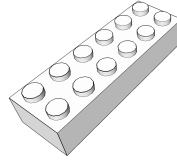

1

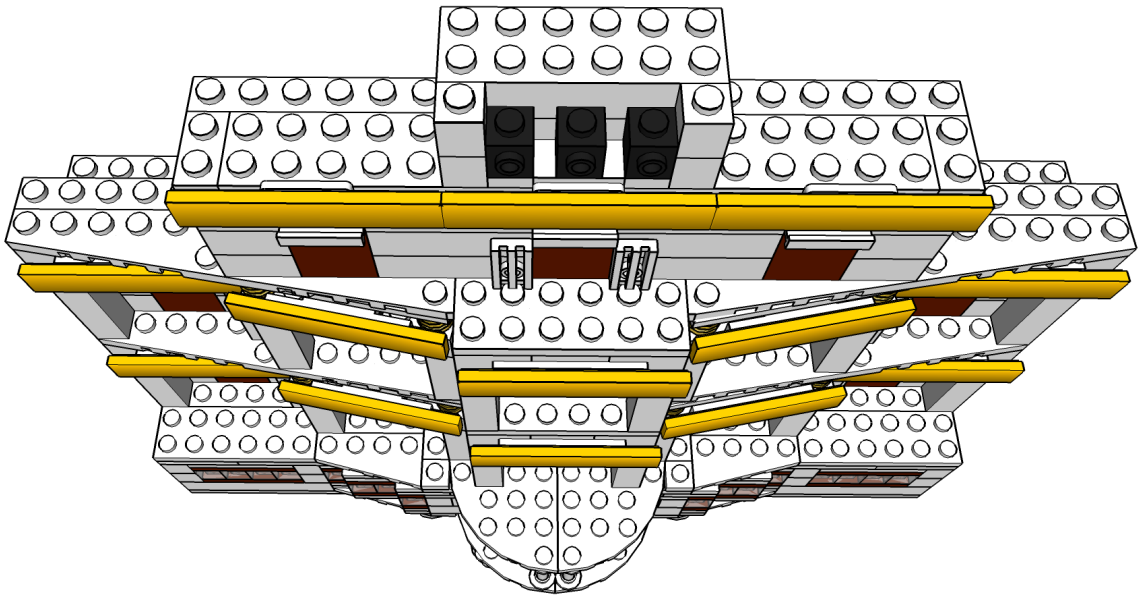

Step 5

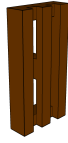

3

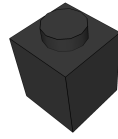

3

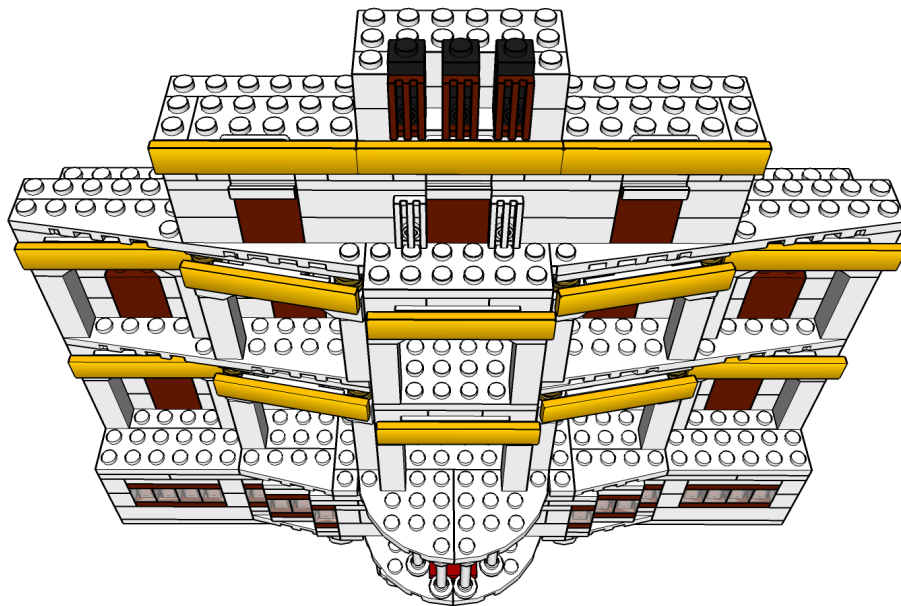

Step 6

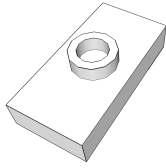

1

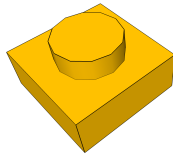

2

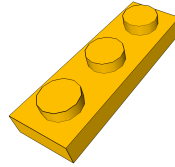

2

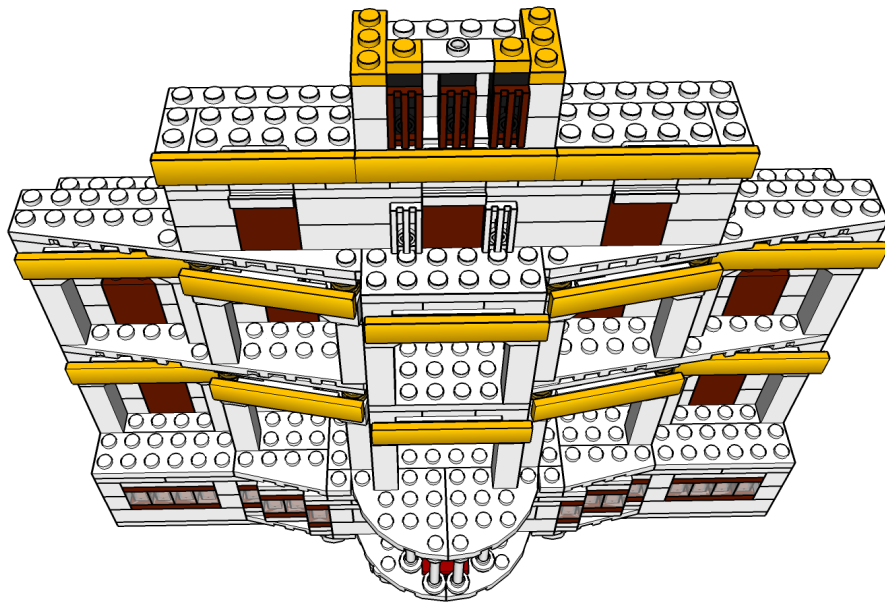

Step 7

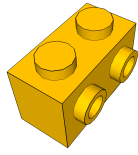

2

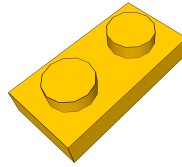

1

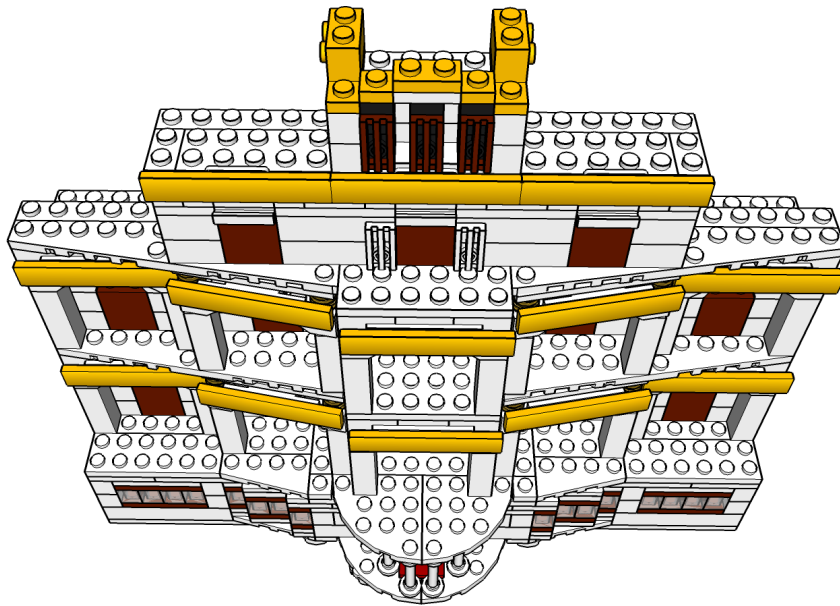

Step 8

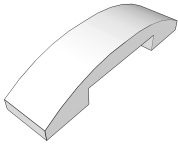

1

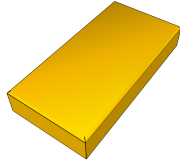

2



2

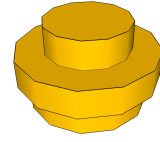

2

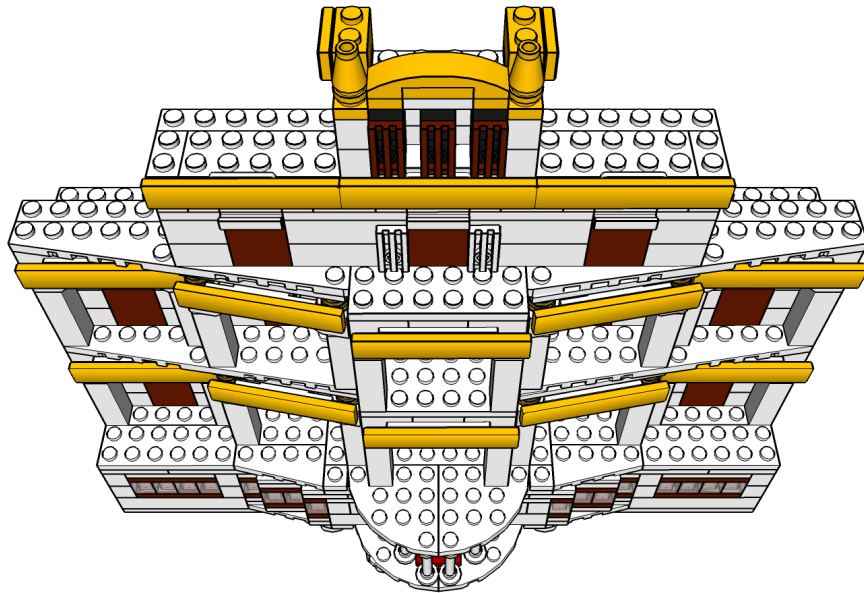

Step 9

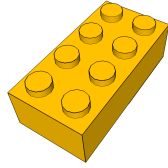

1

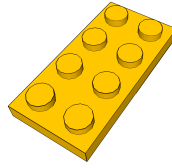

1

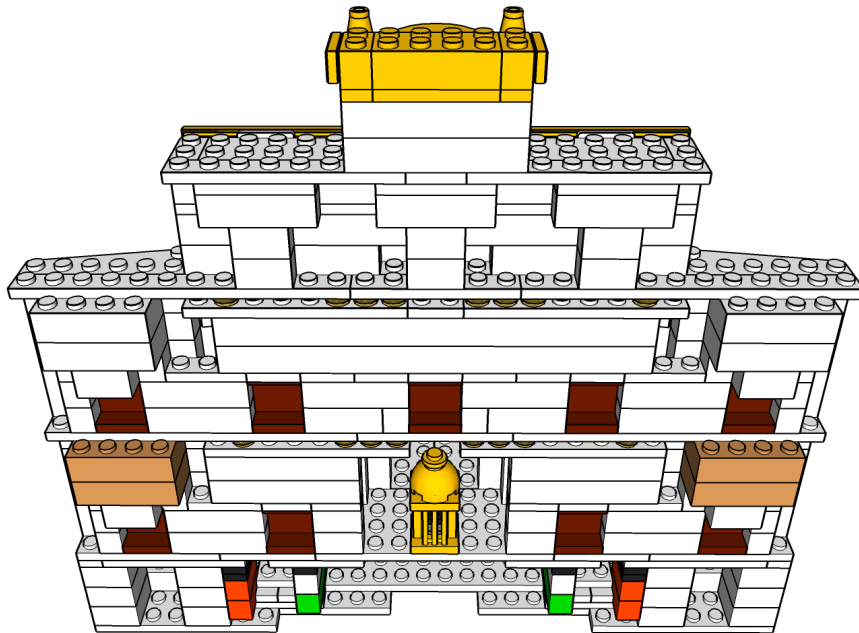

Step 10

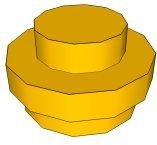

1



1

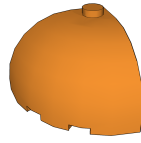

2

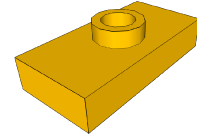

1

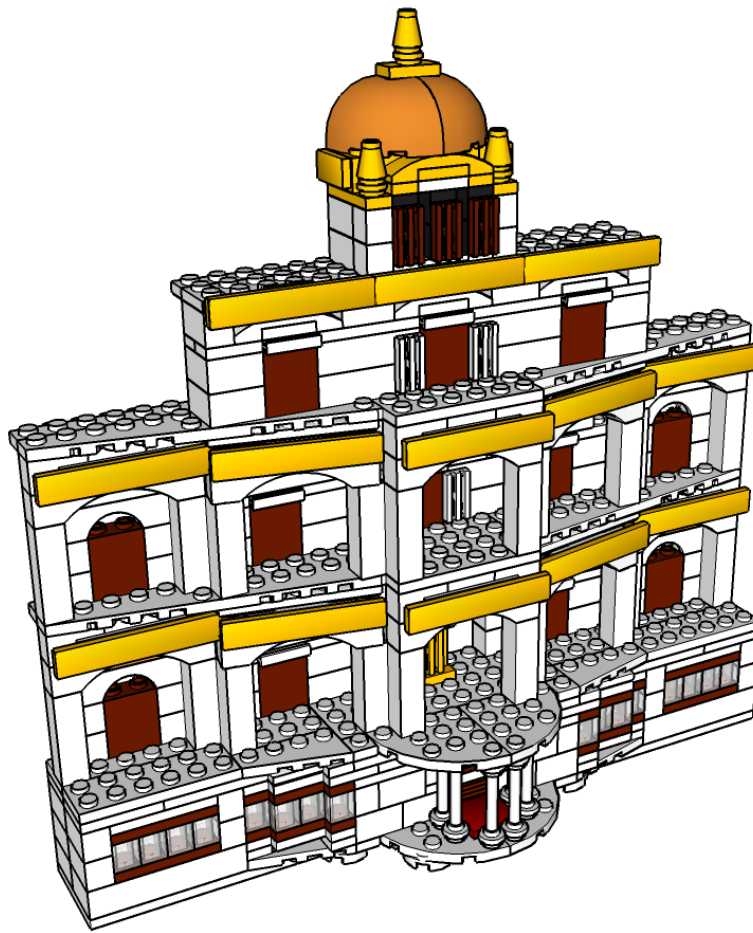

Step 11

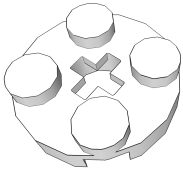

4

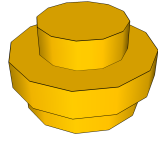

4

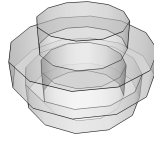

8

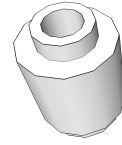

4

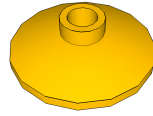

4

Build Four

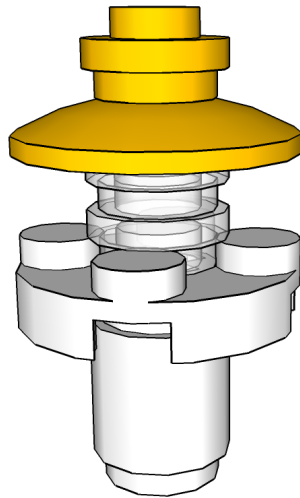

Step 12

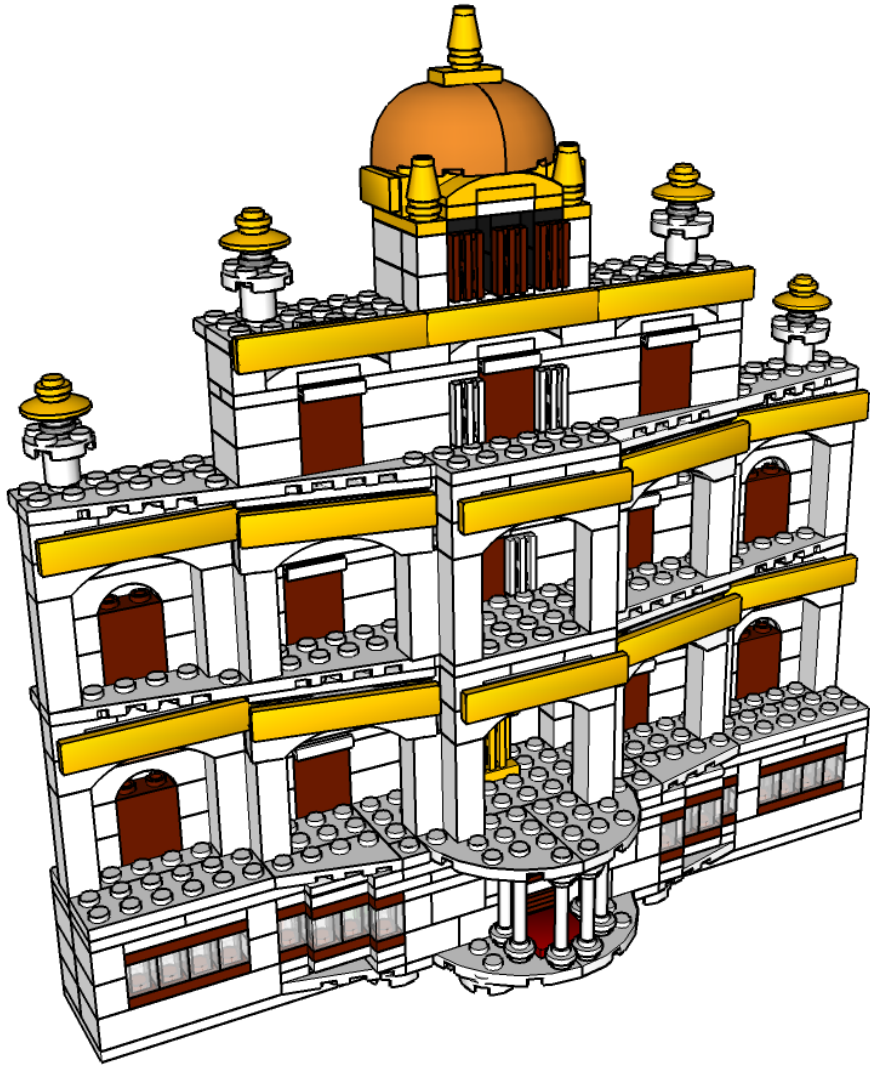

Step 13



1



1

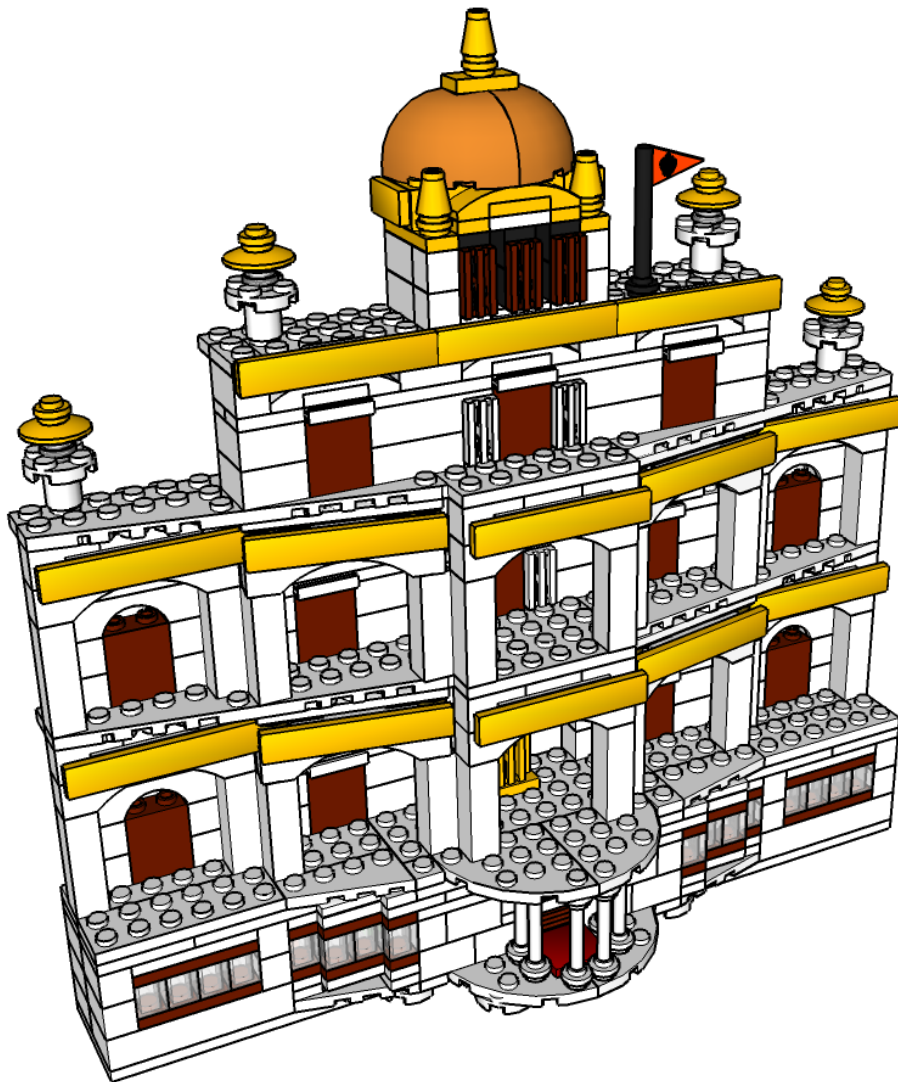

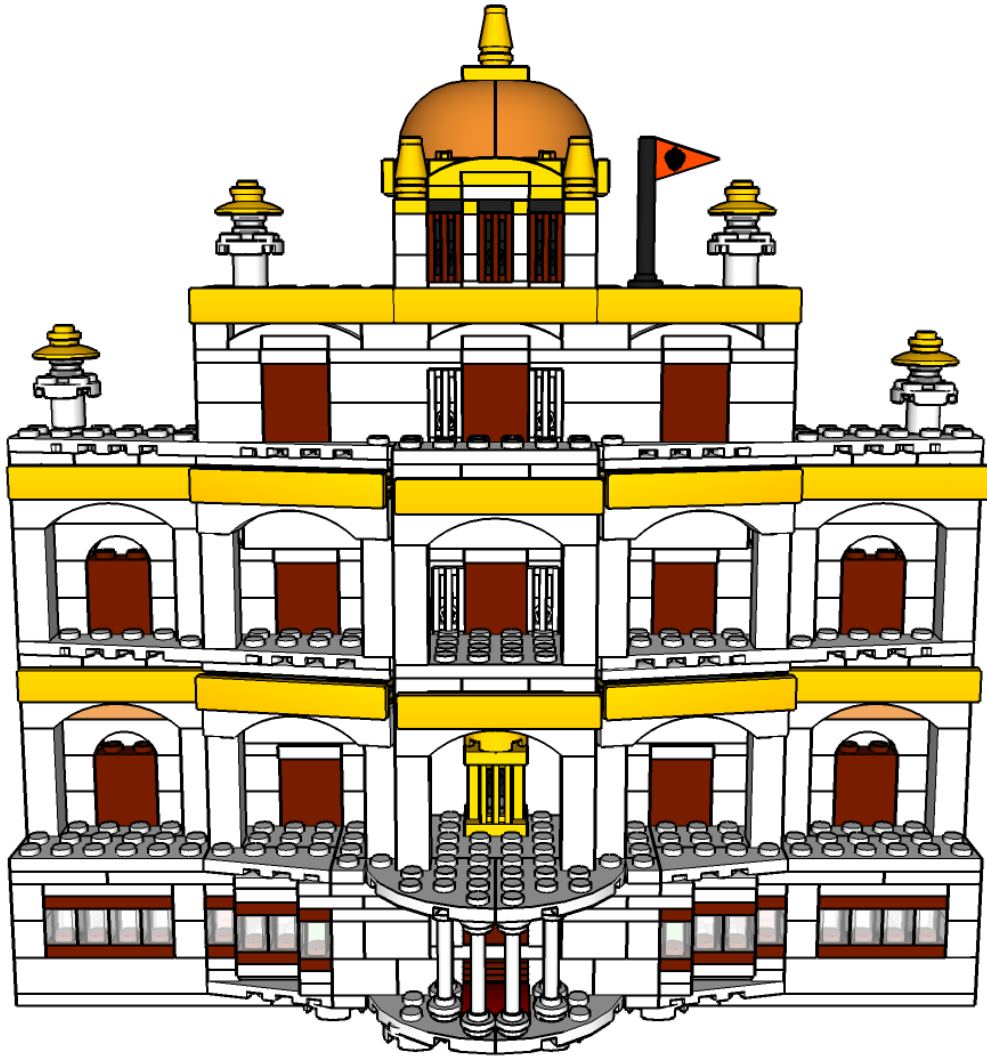

Sources

1. Allaboutsikhs.com
2. Guru Granth-Panth : Institution of Sikh Studies Publication
3. Sketch of the Sikhs
4. Mahan Kosh
5. Freeakaltakht.org